



TEREP-ICR

TECHNICAL REPORTS OF THE
INSTITUTE OF CETACEAN RESEARCH

No. 2

December 2018



TEREP-ICR is published annually by the Institute of Cetacean Research.
ISSN: 2433-6084

Copyright © 2018, The Institute of Cetacean Research (ICR).

Citation

Entire issue:

Institute of Cetacean Research. 2018. *Technical Reports of the Institute of Cetacean Research (TEREP-ICR) No. 2*. The Institute of Cetacean Research, Tokyo, Japan, 100 pp.

Individual reports:

'Author Name'. 2018. 'Report title'. *Technical Reports of the Institute of Cetacean Research (TEREP-ICR) No. 2*: 'pp'-'pp'.

Editorial correspondence should be sent to:

Editor, TEREP-ICR

The Institute of Cetacean Research,

4-5 Toyomi-cho, Chuo-ku, Tokyo 104-0055, Japan

Phone: +81(3) 3536 6521

Fax: +81(3) 3536 6522

E-mail: webmaster@icrwhale.org

TEREP-ICR is available online at www.icrwhale.org/TEREP-ICR.html

Cover photo: A southern right whale in the Antarctic.

Copyright © 2018, The Institute of Cetacean Research (ICR).

**TECHNICAL REPORTS OF THE
INSTITUTE OF CETACEAN RESEARCH**

TEREP-ICR

No. 2

The Institute of Cetacean Research (ICR)

Tokyo, 2018

Foreword

It is a pleasure for me to introduce the second issue of the Technical Reports of the Institute of Cetacean Research (TEREP-ICR). As explained in the presentation of the first issue, the main objective of the TEREP-ICR is to describe and report on the process, progress, or results of technical or scientific research, or the state of a technical or scientific research program conducted by the Institute of Cetacean Research (ICR).

I believe that the production of the first issue of the TEREP-ICR was an important step toward achieving the aim stated above. TEREP-ICR No. 1 was distributed widely among the scientific community. It was distributed among approximately 100 individual scientists from Japan and 30 foreign countries. It was also distributed to approximately 160 research institutions (including universities, research institutes, public libraries, museums and aquariums) both in Japan and foreign countries. I am happy to report that positive comments were received from several colleagues about the high quality of TEREP-ICR No. 1. Some international colleagues noted that TEREP-ICR will contribute to increased research collaboration because it informs external scientists of the kind of data/samples collected and the kind of technical and scientific research conducted by ICR scientists. I appreciate these comments because they validate the main purpose of the TEREP-ICR.

I sincerely hope that this second issue of the TEREP-ICR will continue contributing to an increased understanding of the technical and research activities conducted by the ICR among the national and international scientific community.

Dr. Yoshihiro Fujise
Director General ICR
Tokyo, December 2018

Editorial

Welcome to the second issue of the Technical Reports of the Institute of Cetacean Research (TEREP-ICR).

This second issue contains nine research articles and one commentary article. The first research article interprets the results of several biological and ecological studies on large whales under the JARPA and JARPAII in the Antarctic ecosystem in the context of two hypotheses, the 'krill surplus' hypothesis at the middle of the past century and the hypothesis of recovery of large whales since the 1980's. The second article explains the purposes and the progress of the ecosystem modeling studies conducted by the ICR in both the Antarctic and western North Pacific. The next article summarizes the information on spatial and temporal distribution of large whales in the Indo-Pacific region of the Antarctic, emphasizing the importance of long-term monitoring research programs. Other articles summarize the biological information obtained from Antarctic fin and western North Pacific Bryde's whales, two species for which biological information is very limited for the period after the commercial whaling. This issue also contains an article explaining the criteria of the ICR for evaluating novel non-lethal research techniques in whales. In relation to this, one article is included that explains and summarizes the research being conducted to investigate the feasibility of novel non-lethal techniques for investigating the age and reproductive status of whales. Two articles deal with results of routine non-lethal research, the first summarizes the surveys on marine debris conducted by the ICR in the Antarctic, and the second summarizes the data on photo-identification of three Antarctic baleen whale species in the Antarctic. The commentary article deals with the issue of the ethics of whaling.

This second issue also includes sections to outline the contribution of ICR scientists to national and international meetings in 2018 as well as their contribution in terms of peer reviewed publications up to December 2018.

I hope you will find this second issue informative and useful.

Dr. Luis A. Pastene
Editor TEREP-ICR
Tokyo, December 2018

Contents

Foreword	i
Editorial	iii
Contents	v
 Technical Reports	
Fujise, Y. and Pastene, L.A. Cetaceans as indicators of historical and current changes in the Antarctic ecosystem	1
Hakamada, T. and Tamura, T. An overview of the Institute of Cetacean Research work on ecosystem modeling in the Antarctic and western North Pacific	14
Matsuoka, K. and Hakamada, T. Geographical distribution of whales in the Indo-Pacific region of the Antarctic based on JARPA and JARPAII sighting data collected in the period 1987/88–2008/09	20
Bando, T. Earplug-based age determination and estimation of biological parameters in North Pacific Bryde’s whales based on samples collected by JARPNII	32
Mogoe, T. Biological observations of fin whales sampled by JARPAII in the Indo-Pacific region of the Antarctic	38
Mogoe, T. Field and analytical protocol for the evaluation of novel non-lethal techniques in the Japanese whale research programs	50
Goto, M. and Inoue, S. Results of feasibility studies on novel non-lethal techniques to address the main objectives of NEWREP-A	56
Isoda, T., Tamura, T. and Pastene, L.A. Using JARPA and JARPAII platforms for investigating the occurrence of marine debris in the Indo-Pacific region of the Antarctic	64
 Technical Reports-Note	
Matsuoka, K. and Pastene, L.A. A summary of photo-id information of blue, southern right and humpback whales collected by JARPA/JARPAII in the Indo-Pacific region of the Antarctic	74
 Commentary	
Ohmagari, K. Ethics of Whaling: Is whaling truly immoral?	77
International meetings	79
National meetings	81
Peer-reviewed publications	83

Technical Report (not peer reviewed)

Cetaceans as indicators of historical and current changes in the Antarctic ecosystem

Yoshihiro FUJISE* and Luis A. PASTENE

Institute of Cetacean Research, Toyomi-cho 4–5, Chuo-ku, Tokyo 104–0055, Japan

*Contact e-mail: fujise@cetacean.jp

ABSTRACT

Changes in the Antarctic ecosystem are triggered by anthropogenic and natural factors. This paper reviews the scientific information on whales produced mainly by the Institute of Cetacean Research (ICR), that could be indicative of changes in the Antarctic ecosystem in the context of two hypotheses, the ‘krill surplus’ hypothesis in the middle of the past century, and the hypothesis of recovery of krill-eater large whales since the 1980’s. The information in the Indo-Pacific region of the Antarctic (70°E–170°W) showed that the increased krill availability in the middle of the past century could have been translated into better nutritional conditions for some krill predators like the Antarctic minke whale, resulting in a decreasing trend in the age at sexual maturity and an increasing trend in the recruitment rate and total population size of this species between approximately 1940 and 1970. The evidence available since the 1980’s showed a sharp increase in the abundance of some species such as the humpback and fin whales, which had been heavily exploited in the first half of the past century. The evidence also showed that, in parallel to this increase, the nutritional condition of Antarctic minke whales has deteriorated as revealed by a decrease in energy storage and stomach content weight since the 1980’s. This observation is consistent with the stable trend of age at sexual maturity, recruitment and abundance of this species after the 1980’s. Therefore the historical demographic changes observed in the Antarctic minke whale are consistent with the pattern expected under the ‘krill surplus’ hypothesis, while the demographic and ecological changes observed in recent years are consistent with the changes expected under the reverse of the ‘krill surplus’ hypothesis.

INTRODUCTION

The Antarctic ecosystem is a very dynamic one with changes in species composition and habitat occurring through time. Within this ecosystem the Antarctic krill (*Euphausia superba*) is a key prey species supporting different species of baleen whales, pinnipeds, birds and fish. Changes in the ecosystem can be derived from human interventions or from natural causes. One example of the former is the large-scale exploitation of whales in the first half of the 20th Century, which has been discussed by several authors, notably by Laws (1977; 1985). Exploitation of large whales in the Antarctic Ocean started in 1904. Several species of krill-eater large whales such as Antarctic blue (*Balaenoptera musculus intermedia*) and humpback (*Megaptera novaeangliae*) whales were heavily depleted by commercial whaling by the first half of the past century. Other species such as the fin (*B. physalus*) whales were depleted during the second half of the 20th Century. Large changes in the biomass of some whale

species had a strong effect on the demography of other krill-eater predators in the Antarctic ecosystem (Laws 1977; 1985).

One example of the latter are the environmental changes reported in recent years for some parts of the Antarctic. For example Fraser *et al.* (1992) suggested that the increase in chinstrap penguin populations in the last four decades (1950’s–1990’s) were due to a gradual decrease in the frequency of cold years with extensive winter sea ice cover resulting from environmental warming. Their observation was supported by a multidisciplinary winter expedition to the Scotia and Weddell seas, satellite images of ocean ice cover, and the analysis of long-term surface temperature records and penguin demography. Less ice cover means wider open waters available for penguin’s feeding on krill. This observation contradicted the hypothesis that the increases in the penguin population resulted from an increase in prey availability brought on by the decrease in baleen whale stocks. They cited modeling work that predicted that the

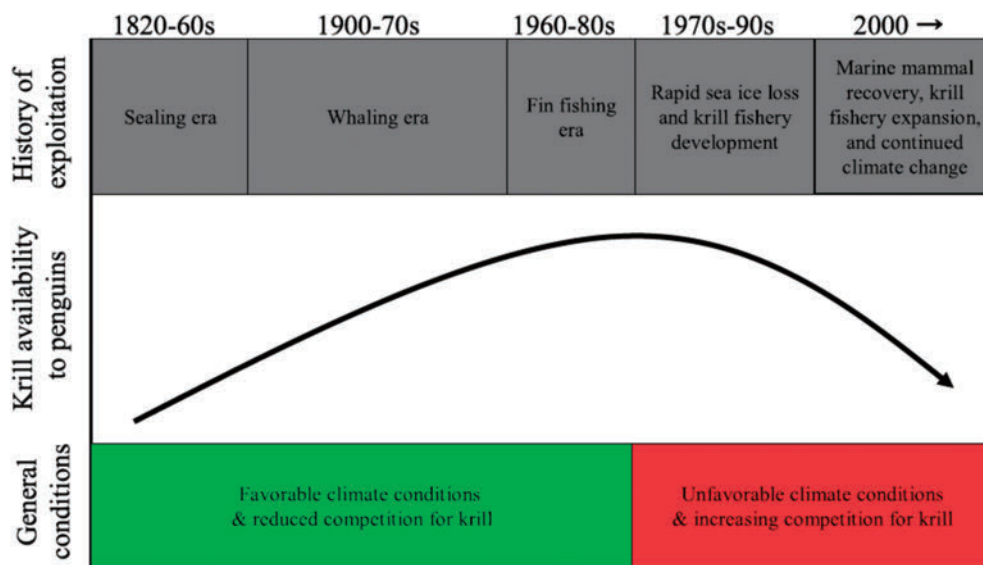

Figure 1. Schematic diagram of ecosystem perturbation in the Scotia Sea (after Trivelpiece *et al.*, 2011).

Table 1

Biological and ecological parameters monitored from whales and their environment to investigate change in the ecosystem.

Research parameter	How the information is obtained	Relevance of monitoring
Krill biomass	Echo-sounder and net surveys	Krill is a key species in the Antarctic ecosystem. Changes in its abundance have effects on predators and the whole ecosystem.
Whale abundance	Systematic sighting surveys	Fluctuation of abundance of whales through time is important for their management. Different levels of whale abundance have different impacts on krill.
Whale distribution	Systematic sighting surveys	Distribution of whale species can change with time in response to changes in abundance and/or changes in oceanographic conditions/krill availability.
Whale recruitment	Population dynamic models that use age and abundance information from whales	Same as above. Index of young whale abundance.
Blubber thickness, fat weight and girth	Direct measurements from sampled whales	Index of body condition. Better nutritional condition (e.g. better availability of krill) will be reflected in thicker blubber, heavier fat and larger girth.
Stomach content weight	Direct measurements from sampled whales	Index of body condition. Better nutritional condition will be reflected in heavier stomach contents.
Age at sexual maturity (ASM)	Examination of transition phase in earplugs; examination of ovaries and testis.	Better nutritional conditions will be reflected in a shift of the ASM to younger ages e.g. whales will be able to reproduce at younger ages.
Pregnancy rate	Examination of ovaries and uterus	Better nutritional conditions will be reflected in higher pregnancy rates.
Oceanographic conditions	Systematic oceanographic surveys based on CTD and XCTD	Changes in oceanographic conditions will affect distribution and krill biomass and in turn the abundance and distribution of whales. Changes in oceanographic conditions might indicate an effect of climate changes.

benefits of a reduction in baleen whales would have been most directly conferred to predators of similar size and behavior, namely, other whales (Fraser *et al.*, 1992). However more recent analyses in the Antarctic Peninsula and Scotia Sea concluded that the chinstrap penguin instead may be among the most vulnerable species affected by a warming climate (Trivelpiece *et al.*, 2011).

Trivelpiece *et al.* (2011) presented a very informative diagram of ecosystem perturbation in West Antarctic (Scotia Sea) due to both, anthropogenic reasons such as the commercial over-exploitation of marine resources (sealing from 1820 to the 1960's, whaling from 1900 to 1970; fishing for ice fishes and Notothenids from 1960–1980), and natural reasons (climate-change effects from the 1970's). They noted that a pelagic trawl fishery for krill also developed from the 1970's, and that in the 2000's, the once-depleted marine mammal populations had recovered or were recovering, that the krill fishery was expanding, that climate change was progressing and that Adelie and chinstrap penguin populations were decreasing (Figure 1). The causes of ecosystem changes in the Antarctic are therefore complex, and to understand those causes, long-term monitoring research programs focused on collecting biological data of krill predators as well as data on sea ice cover and environmental variables, are important.

Previous studies have documented ecosystem changes in West Antarctic, and have considered environmental variables and demographic information of land-based krill predators. The objective of this study was to review the scientific evidence for expected changes in the Indo-Pacific region of the Antarctic, in the context of some established hypotheses. The evidence is based mainly on biological and ecological data of baleen whales, sea-based predators, collected by ICR. Table 1 shows the data monitored in whales and their environment, which are informative of changes in the ecosystem.

KEY BALEEN WHALES IN THE ANTARCTIC ECOSYSTEM

Baleen whale species, except the Bryde's whale, migrate seasonally between low latitude breeding areas in winter to high latitude feeding areas in the Antarctic in summer. The main prey of baleen whales such as Antarctic blue, fin, humpback and Antarctic minke (*B. bonaerensis*) whales is the Antarctic krill therefore their summer migrations to the Antarctic are related to areas of krill concentrations as those shown in Figure 2. Breeding areas of the humpback whales occurring in the Antarctic research area are located in both Western and Eastern Australia.

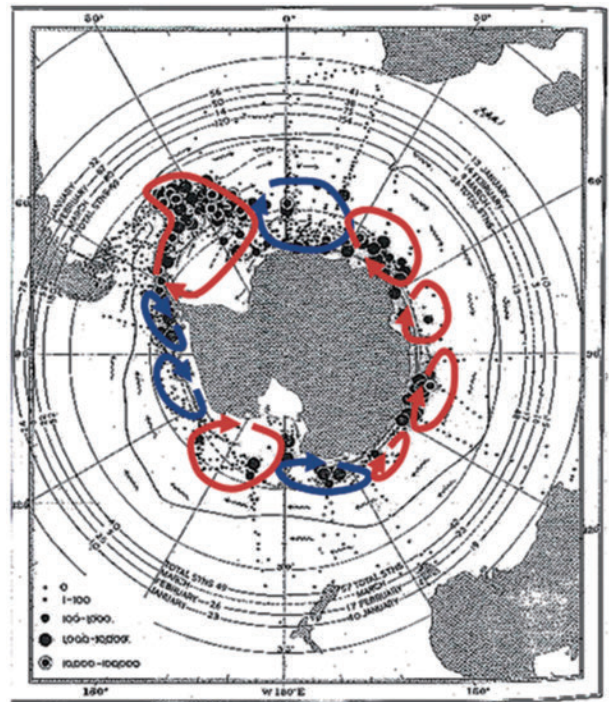

Figure 2. Areas of krill distribution in the Antarctic associated with gyres (after Nicol, 2006).

Breeding areas for the other species are assumed to be in low latitudes of the eastern Indian and western South Pacific Oceans.

Antarctic blue whale

This is the largest baleen whale species. The record for a whale killed in the Southern Hemisphere in the first half of the past century was a body length of more than 30m and weight of nearly 180 tons. During the austral summer season blue whales are distributed mainly above the Antarctic Convergence to the ice edge. Current abundance in all of the Antarctic is approximately 3,000 animals.

Fin whale

This is the second largest baleen whale species with a maximum length of 27.1m and weight of 120 tons. During the austral summer season fin whales are found extensively south of 50°S, most commonly north of 60°S (Branch and Butterworth, 2001). In the Antarctic fin whales feed on krill. The existing estimates from limited parts of the range covered are of the order of several thousand animals.

Humpback whale

This is a highly migratory species with a maximum body length of 17m and weight of 40 tons. During the austral summer season it is distributed south of the Antarctic Convergence to the ice edge but just north of the main

distribution area of Antarctic minke whale. In the Antarctic, humpback whales feed on krill. The total current Southern Hemisphere abundance is probably at least 60,000.

Antarctic minke whale

This is one of the smallest baleen whale species with a maximum body length of 10.7m and weight of 10 tons. During the austral summer season it is distributed mainly around the pack-ice and feeds on krill. Abundance of Antarctic minke whale in the Antarctic was estimated at 515,000 animals (IWC, 2013).

RESEARCH AREA

The review was focused on the Indo-Pacific region of the Antarctic, in the longitudinal sector between 70°E and 170°W, south of 60°S, including both Indian (Area IV according to International Whaling Commission (IWC) terminology, 70°–130°E) and Pacific (Area V according to IWC terminology, 130°E–170°W) sectors. The research area includes Prydz Bay as its western boundary and the Ross Sea as the eastern boundary.

CHANGES IN THE ANTARCTIC ECOSYSTEM

The review of evidence of changes in the Indo-Pacific region of the Antarctic is treated in two periods, historical and current. The former corresponds to the period approximately from the start of commercial whaling in the Antarctica in 1904 until approximately 1970’s, which Trivelpiece *et al.* (2011) characterized as ‘favourable climate conditions and reduced competition for krill’ (Figure 1). The latter corresponds to the period from the 1970’s–1980’s to recent years, which those authors char-

acterized as ‘unfavorable climate conditions and increasing competition for krill’ (Figure 1).

Historical changes

The ecological effect of the large-scale exploitation of whales in the first half of the 20th Century has been discussed by several authors, notably by Laws (1977; 1985). Exploitation of large whales in the Antarctic Ocean started in 1904. Several species of large whales such as blue and humpback whales were heavily depleted by the first half of the past century (Figure 3). Other species such as the fin and sei whales were depleted during the second half of the 20th Century. Commercial exploitation of the Antarctic minke whale started in the early 70’s when all other baleen whale species were already depleted. Table 2 shows the original and current (by 1980) abundance of large whales exploited in the Southern Hemisphere (mainly Antarctic). In the Southern Hemisphere the abundance of large whale species such as the blue and humpback whales decreased to a minimal percentage of the original abundance before exploitation. In the case of the Antarctic minke whales, which were not exploited during the first half of the past century, the current abundance has not changed with regard the original abundance.

As noted earlier, the Antarctic krill is a key prey species in the Antarctic ecosystem supporting different species of baleen whales, pinnipeds, birds and fish. Some researchers have suggested that following the main exploitation period of large baleen whales in the Antarctic (approximately at the middle of the past century) some 150 million tons of ‘surplus’ annual production of Antarctic krill (Figure 4) became available for other krill predators, such as Antarctic minke whales, crabeater seals, fur seals, pen-

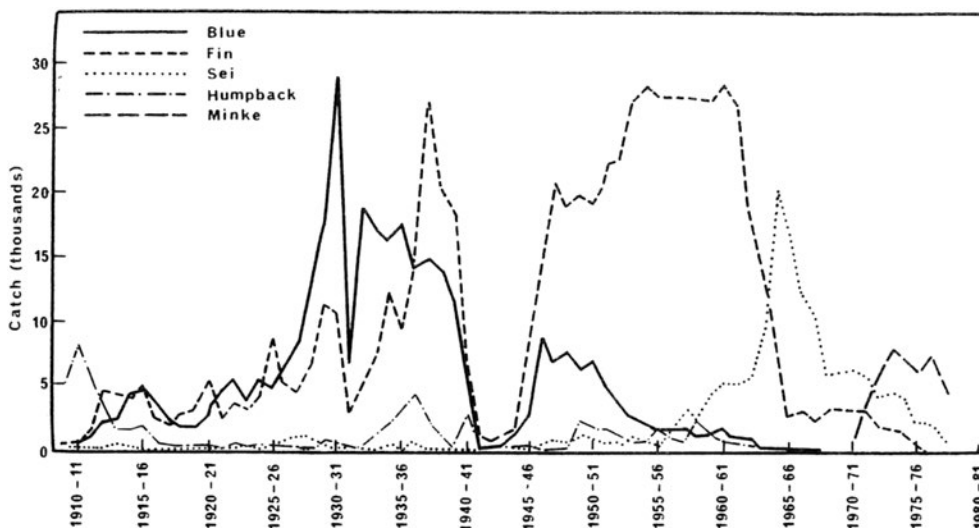

Figure 3. Catches of baleen whales in the southern Hemisphere, 1910–1977 (after Allen, 1980).

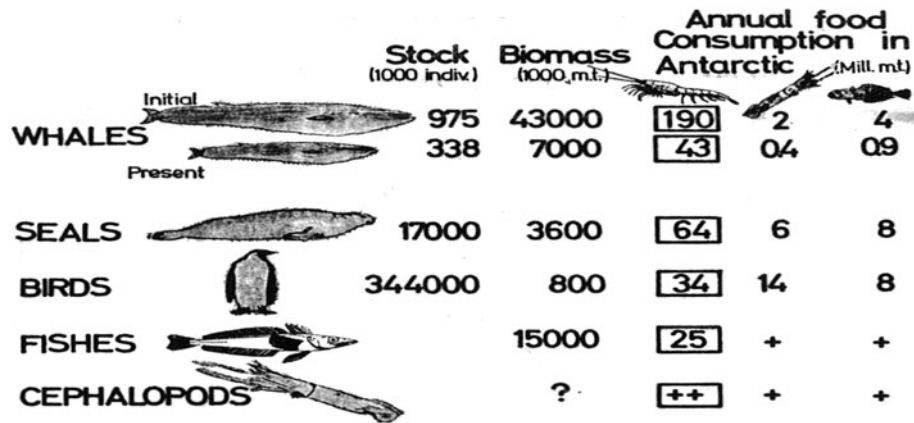

Figure 4. Initial and present (1970's) biomass and annual krill consumption of exploited large baleen whale species and other predators in the Antarctic (after Laws, 1977; Sahrhage, 1984).

Table 2

Original and current (by 1980) abundance of exploited large whales in the Southern Hemisphere (modified of Allen, 1980).

	SPERM Male Female*	RIGHT BOWHEAD	GRAY	HUMPBACK	BLUE	FIN	SEI	BRYDE'S	MINKE	
TOTAL POPULATIONS**										
Southern Hemisphere										
Original	625 625	(100+)	—	—	130	220	490	191	(30)	205
Current	460 510	(3 ²)	—	—	3	11	103	37	(30)	205
%	74 82	(3)	—	—	2	5	21	19	100	100

guins and some albatrosses which took advantage of this food surplus to increase their abundance. This is the so-called 'krill surplus' hypothesis (Laws, 1977; 1985).

Inter-specific effects of the surplus hypothesis

Antarctic minke whale

As shown in Table 2, Antarctic minke whales were not exploited in the first half of the past century and the commercial exploitation of this species only started in the 1970's at a moderate scale under management of the IWC. The expectation here was that the krill surplus by the middle of the past century translated to better nutritional conditions, which should have been reflected in changes in demographic parameters of this species. In particular we focus here on the information on age at sexual maturity and total abundance.

Changes in the age at sexual maturity (ASM) indicate change in nutritional conditions of the whales, which in turn could indicate less or more food availability in the environment. Better nutritional conditions will be reflected in a shift of the ASM to younger ages e.g. whales will be able to reproduce at younger ages and as a consequence the populations will growth faster (Table 1). One of the methods for determining age at sexual maturity in whales is examination of the 'transition phase' in the

earplugs. The earplugs of several baleen whale stocks exhibit seasonal growth layers which have been shown for some species to indicate the age of the animals. A transition from early, irregular layers, to later, more regular layers can be seen in these earplugs, and this is thought to indicate the age at maturity of the whale (Thomson *et al.*, 1999). Historical changes in the age at sexual maturity can be investigated when the analyses are carried out on cohorts (groups of whales born in the same year).

Earplugs of Antarctic minke whales were collected during the period of commercial whaling in the early 1970's, and during Japanese whale research in the Indo-Pacific region of the Antarctic (JARPA and JARPAII), for more than 25 years. Thomson *et al.* (1999) showed a decline in the average age at transition in Antarctic minke whales in the Indian sector from roughly 11 for the cohorts of the 1950's to roughly 7 for those of the 1970's, and the trend was similar for females and males. This work was updated by Bando *et al.* (2014) by using a large number of samples, and analyses conducted on two biological stocks, one mainly distributed in the Indian Ocean sector and the other in the Pacific Ocean sector.

These results suggested that the nutritional conditions were optimal for Antarctic minke whales after a period in which other krill-predators species such as the Antarctic

blue and humpback whales were already depleted (Figure 3).

The Scientific Committee (SC) of the IWC has been applying statistical catch-at-age (SCAA) analyses on Antarctic minke whales since 2005. A summary history of the application of SCAA to this species was presented by Punt (2014), and an assessment of Antarctic minke whales using SCAA was reported by Punt *et al.* (2014).

The data used when conducting assessment by SCAA on Antarctic minke whales consisted of catches, abundance estimates, length frequency data, and conditional age-at-length data. Different series of abundance estimates were used e.g. those from the IWC SC's International Decade of Cetacean Research/Southern Ocean Whale and Ecosystem Research (IDCR/SOWER) as well as those from Japanese dedicated sighting surveys in the Indo-Pacific region of the Antarctic. Biological data were available from the period of commercial whaling (Japan and the former Soviet Union), and from Japanese whale research in the Indo-Pacific region of the Antarctic (JARPA and JARPAII), for more than 25 years.

The SCAA assessment on Antarctic minke whale involved a 'reference' case and several sensitivity tests. These sensitivity tests explored sensitivity to the weight assigned to the various data sources and penalties, the assumptions related to vulnerability, natural mortality and catchability, and to the use or otherwise of the Japanese research's index data (Punt *et al.*, 2014).

Results presented here refer to the 'reference' case in Punt *et al.* (2014), which was robust to the sensitivity tests conducted (Figure 6 for the Indian sector). As shown in Figure 6, the stock was estimated to have increased from 1930 until the early 1970's, with the stock having declined subsequently thereafter. The increase in abundance was due primarily to an increase in recruitment owing in turn to an increase in carrying capacity (Punt *et al.*, 2014).

For historical changes examined in this section, it is interesting to note that the increase from 1930 to 1970's roughly coincided with the period in which the age at sexual maturity decreased. Again these results suggested that the nutritional conditions were optimal for Antarctic minke whales after a period in which other krill-predator species such as the Antarctic blue and humpback whales were already depleted (Figure 3).

Summary

According to the 'krill surplus' hypothesis, the increased krill availability was translated into better nutritional conditions for some krill predators like the Antarctic minke whale. In the case of this species this resulted in some

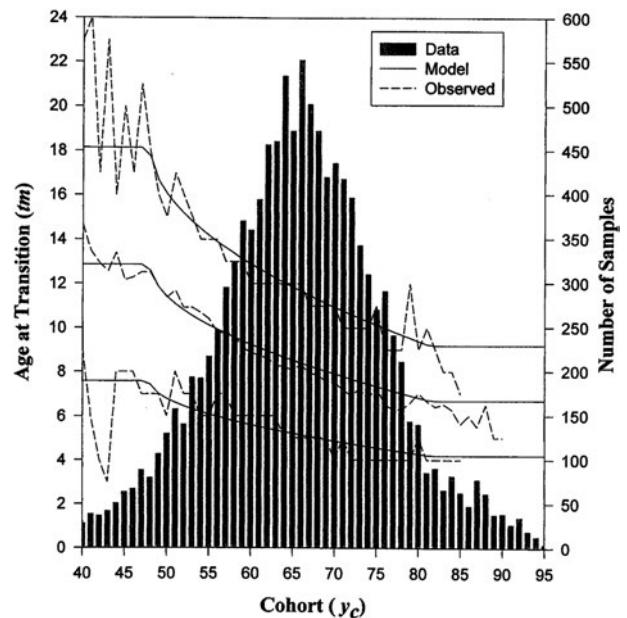

Figure 5. Changes in the age at sexual maturity of Antarctic minke whale, by cohort (Indian Ocean sector). Age at sexual maturity changed from around 11 years in 1950s cohorts to around 7 years in 1970s cohorts (middle curve) (after Thomson *et al.*, 1999).

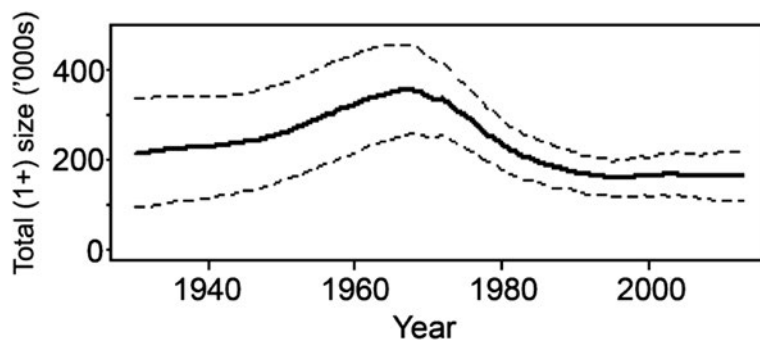

Figure 6. Time trajectories of total (1+) population size of Antarctic minke whales in the Indian sector (base-case). The dotted lines indicate 95% asymptotic confidence intervals (after Punt *et al.*, 2014).

biological changes such as the observed decreasing trend in the age at sexual maturity between approximately 1940 and 1970 (Figure 5), which coincide with the period of depletion of some key krill-eater large whale species (Figure 3). A low age at sexual maturity favored an increase in the recruitment rate and total population size in a similar period (Figure 6).

The Antarctic minke whale perhaps reached the increased maximum carrying capacity by the late 1960s, and then the stock responded by stabilizing the age at sexual maturity at 7–8 years old (Figure 5). This biological process should have resulted in a stable continuous high rate of newborns after 1970 since the recruitment was rather stable after 1970 (Figure 6). The trend in recruitment is consistent with the trend in total abundance of Antarctic minke whale estimated by sighting data which has been broadly stable since the 1980's.

Finally it should be noted that the period of demographic changes observed in Antarctic minke whales coincides with the period 1900–70's ('whaling era') in Trivelpiece *et al.* (2011), which they characterized as 'favorable climate conditions and reduced competition for krill' (Figure 1). Such conditions allowed for rapid growth and increase in populations of the Antarctic minke whale and other krill-eater predators in that period.

Current changes

Commercial whaling of humpback, Antarctic blue and fin whales in the Antarctic was banned in 1963, 1964 and 1976, respectively. As an effect of these conservation measures, the abundance of these species increased in recent decades, which points toward a recovery from past commercial exploitation. The speed of recovery varies among these species and among stocks within these species. The increase in the abundance of large whale species that feed on krill in the Antarctic means less food available for species like the Antarctic minke whale that once benefited from the surplus of krill. It was expected that these conditions, which correspond to the 'reverse' of the krill surplus hypothesis, should have some effect on the nutritional conditions and on demographic parameters of Antarctic minke whale and other species that once benefited from the surplus of krill.

Evidence for the increase in abundance of large whales in the Indo-Pacific region of the Antarctic

To estimate abundance of large whales in the Antarctic, systematic sighting surveys have been carried out under the DISTANCE sampling method (Buckland *et al.*, 2015), and the guidelines for surveys and analyses agreed by the

IWC SC (IWC, 2012). The IWC SC carried out three circumpolar sighting surveys under the IDCR/SOWER programs. Japanese researchers also carried out dedicated sighting surveys in the Indo-Pacific region using the same methodology and guidelines.

Matsuoka *et al.* (2011) reported abundance estimates and abundance trends for two populations of the humpback whales, stock D in the Indian sector (Area IV) and stock E in the Pacific sector (Area V). Results showed that the abundance of both stocks has been increasing in the last decades. Abundance and population growth rates of humpback whale in the Indian sector and in the Pacific sector were 31,000 (16.4% increase by year with 95% CI: 9.5–23.3%) and 9,000 (12.1% increase by year with 95% CI: 1.7–22.6%), respectively. The current abundance of the stock in the Indian sector is close to that at its pre-exploitation level. Figure 7 shows the abundance trend

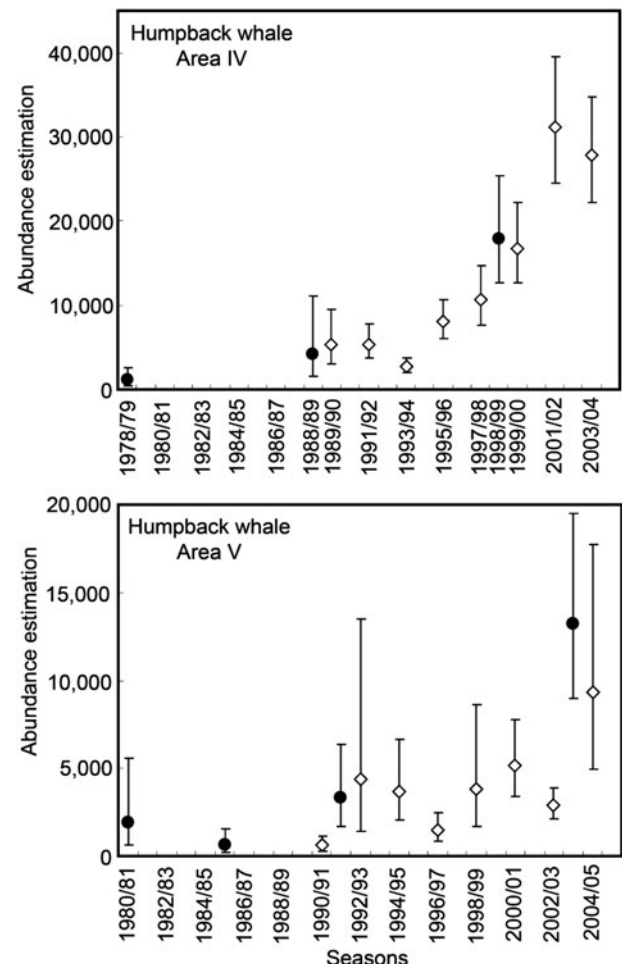

Figure 7. Abundance trend of humpback whale in the Indian sector (Area IV) and Pacific sector (Area V) based on Japanese dedicated sighting surveys. Black dots are abundance estimates based on the IDCR/SOWER surveys, which are consistent with those from the Japanese surveys (after Matsuoka *et al.*, 2011).

of this stock in the Indian and Pacific sectors for the period 1989/90–2003/04, and compares it with the trend estimated using IDCR/SOWER sighting data (Matsuoka *et al.*, 2011). There is a clear increasing trend that is consistent between both Japanese and IDCR/SOWER surveys (see Figures 7).

The abundance and annual population growth rates of fin whales in the Indian sector and Pacific sector based on Japanese dedicated sighting surveys were estimated at 6,514 (16.0% CV: 0.78 increase rate) and 5,241 (12.8% CV: 0.60 increase rate) for the period 1989/90–2004/05, respectively (Matsuoka *et al.*, 2005). It should be noted that abundance estimates for fin whales were made based on data obtained south of 60°S because the Japanese dedicated sighting surveys did not cover the main distribution area of fin whales in the austral summer, which is north of 60°S.

The circumpolar abundance of the Antarctic blue whales based on IDCR/SOWER surveys was estimated at 1,700 (95% Bayesian interval 860–2,900) in 1996. Although this figure corresponds to less than 1% of the original levels, blue whales are increasing at 7.3% per annum (95% Bayesian interval 1.4–11.6%) (Figure 8) (Branch *et al.*, 2004).

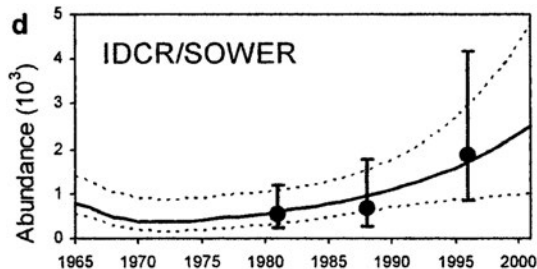

Figure 8. Posterior abundance trajectory (and 95% interval) from 1965, and the IDCR/SOWER abundance estimates for blue whales in the Antarctic (d) (after Branch *et al.*, 2004).

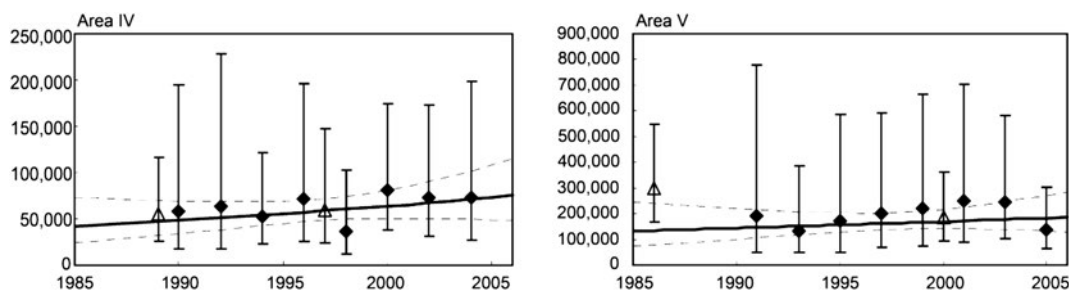

Figure 9. The best case estimates of annual abundance of Antarctic minke whale in the Indian sector (Area IV) and Pacific sector (Area V) together with their 95% CIs. The IDCR/SOWER estimates for a common northern boundary for CPII and CPIII are shown by the open triangles. Confidence intervals include allowance for additional variance. The dashed curves indicate the 95% CIs for the exponential model (after Hakamada *et al.*, 2013).

Possible inter-specific effects of the recovery of large whales

Antarctic minke whale

Trend in abundance

Hakamada *et al.* (2013) estimated abundance and abundance trends of Antarctic minke whale in the Indian sector (Area IV) and Pacific sector (Area V) based on Japanese dedicated sighting surveys (JARPA and JARPAII), under the assumption of $g(0)=1$. Abundance estimates for the Indian sector range from 16,562 (CV=0.542) in 1997/98 to 44,945 (CV=0.338) in 1999/00, while those for the Pacific sector range from 74,144 (CV=0.329) in 2004/05 to 151,828 (CV=0.322) in 2002/03. Estimates of the annual rates of increase in abundance are 1.8% with a 95% CI of [-2.5%, 6.0%] for the Indian sector and 1.9% with a 95% CI of [-3.0%, 6.9%] for the Pacific sector. Adjustments to allow for the $g(0)$ being less than 1 were made by the application of a regression model, developed from the results of the Okamura-Kitakado (OK) method estimate of minke whale abundance from the IDCR-SOWER surveys, which provides estimates of $g(0)$ from the statistics of the minke whale school size distribution in a stratum. With this adjustment, abundance estimates increased by an average of 32,333 (106%) for the Indian sector and 89,245 (86%) for the Pacific sector, while the estimates of annual rates of increase and their 95% CIs changed slightly to 2.6% [-1.5%, 6.9%] for the Indian sector and 1.6% [-3.4%, 6.7%] for the Pacific sector. See Figure 9 for the abundance trends in the two sectors.

In 2012 the IWC SC agreed to a new best abundance estimate for Antarctic minke whale in Antarctic open waters south of 60°S, based on IDCR/SOWER sighting data. The estimates were 720,000 based on the sighting data collected during the CPII (1985/86–1990/91) with 95% CI (512,000, 1,012,000), and 515,000 based on the sighting data collected during the CPIII (1992/93–2003/04) with

95% CI (361,000, 733,000). No significant statistical differences were found between the CPII and CPIII estimates (IWC, 2013).

The estimates in the Indian sector (Area IV) were 55,237 (CV: 0.17) in CPII and 59,677 (CV: 0.34) in CPIII. In the Pacific sector (Area V) were 300,214 (CV: 0.13) in CPII and 183,915 (CV: 0.11) in CPIII.

By considering the 95% CIs of the estimates it can be suggested that the stocks of Antarctic minke whales are broadly stable with at most a slight decline.

Changes in spatial distribution

Figures 10 and 11 show the temporal changes in whale species composition in the Indian sector (Area IV) and Pacific sector (Area V) based on Japanese dedicated sighting surveys. In the Indian sector, humpback whales were more frequently observed than Antarctic minke whales in recent years (Figure 10). In the Pacific sector Antarctic minke whale is still the predominant species (Figure 11).

The increase in abundance of the large whales once depleted by commercial whaling implies changes in the spatial distribution of whale species. Murase *et al.* (2014) examined Japanese dedicated sighting survey data to study the spatial distribution of Antarctic minke whales and humpback whales in the Indian sector (Area IV) during three periods: early (1989/1990, 1991/1992 and 1993/1994), middle (1995/1996, 1997/1998 and 1999/2000) and late (2001/2002, 2003/2004 and 2005/2006). Spatial distribution was estimated using generalized additive models (GAM). Presence or absence of whales was used as the response variable while seafloor depth, distance from shelf break and longitude were used as explanatory variables.

Mean probabilities of occurrence of Antarctic minke whales in the survey area in early, middle and late periods were 0.41, 0.46 and 0.41 while those of humpback whales were 0.14, 0.35 and 0.46. Occupied area indices (probabilities of occurrence of Antarctic minke whales minus probabilities of occurrence of humpback whales) were also calculated. If the index is 1, only Antarctic minke whales were present in a grid cell while only humpback whales were present if the index is -1. If the index is 0, probabilities of presence of Antarctic minke whales and humpback whales in a grid cell were identical. Mean occupied area indices in early, middle and late periods were 0.28, 0.11 and -0.07, respectively. The authors concluded that the spatial distribution of humpback whales expanded during the period investigated while that of Antarctic minke whales remained stable. The results suggested the possibility that competition between humpback and Ant-

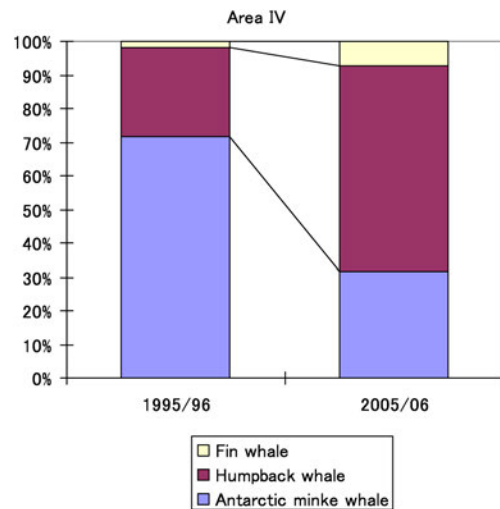

Figure 10. Sighting composition of Antarctic minke, humpback and fin whales in the Indian sector (Area IV) for two Japanese dedicated sighting surveys, 1995/96 and 2005/06. Note that humpback whales are more frequently observed than Antarctic minke whales in recent years (see explanation of data source in Pastene *et al.*, 2014).

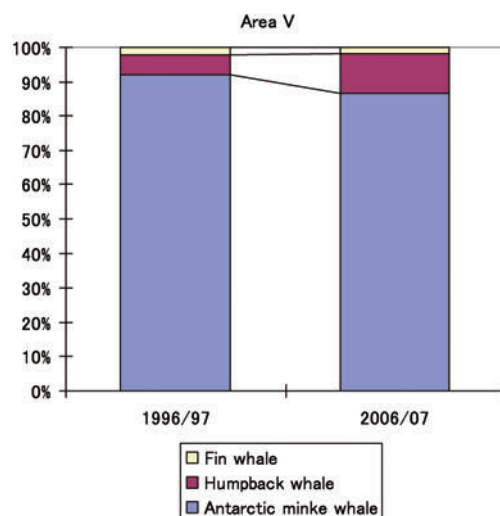

Figure 11. Sighting composition of Antarctic minke, humpback and fin whales in the Pacific sector (Area V) for two Japanese dedicated sighting surveys, 1996/97 and 2006/07. Note that Antarctic minke whale is still the predominant species. The composition of humpback whales in the total sighting have increased but at a slower pace compared to the Indian sector (see explanation of data source in Pastene *et al.*, 2014).

arctic minke whales for habitat in the Indian sector (Area IV) during the period studied could have been intensified as abundance of humpback whales increased. A summary of the results are presented in Figure 12.

It should also be mentioned here that Antarctic minke

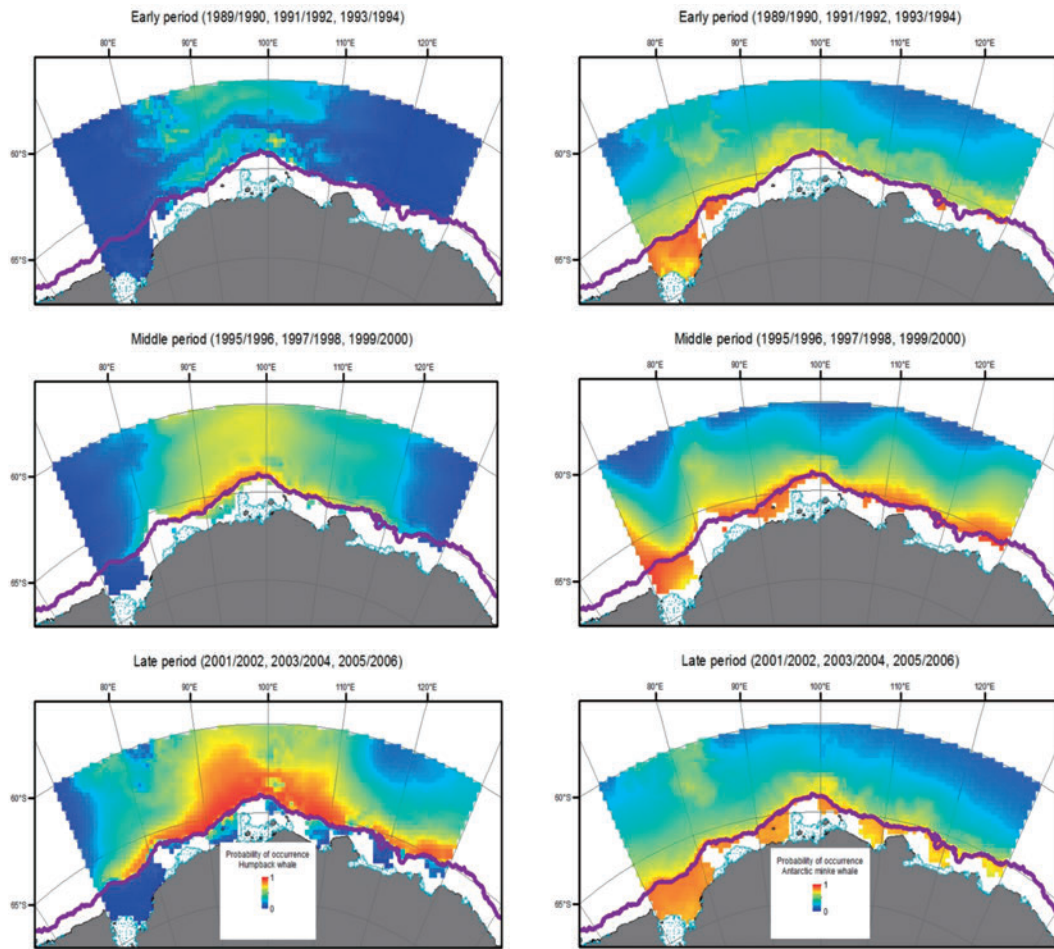

Figure 12. Probability of occurrence of humpback (left) and Antarctic minke (right) whales in the Indian sector (Area IV) in three periods: early, middle and late (after Murase *et al.*, 2014). Red indicate high probability of occurrence.

whales have been observed more frequently in polynias within the pack-ice in recent years (Matsuoka, pers. comm. 2016), reflecting perhaps a response to the geographical expansion of humpback whales.

Nutritional conditions

Nutritional condition in Antarctic minke whales has been investigated through different indices, blubber thickness under the assumption that the amount of lipids increase with the thickness of the blubber, girth and total fat. These data have been collected for more than 25 years by Japanese research (JARPA and JARPA II) in the Indo-Pacific region of the Antarctic (Areas IV and V).

Konishi *et al.* (2008) showed the results of the annual trend in energy storage in sexually mature Antarctic minke whales based on data collected for a period of 18 years in the Indo-Pacific region. Regression analyses clearly showed that blubber thickness, girth and fat weight have been decreasing for nearly two decades. The decrease per year was estimated at approximately

0.02 cm for mid-lateral blubber thickness and 17 kg for fat weight, corresponding to 9% for both measurements over the 18-year period (Figure 13).

Konishi *et al.* (2014) reported the results of an analysis of temporal trend in stomach content weight in the Antarctic minke whale in a 20-year period. A linear mixed-effects analysis showed a 31% (95% CI 12.6–45.3%) decrease in the weight of stomach contents over the 20 years since 1990/91. A similar pattern of decrease was found in both males and females, except in the case of females sampled at higher latitude in the Ross Sea. These results were consistent with the decline in energy storage reported above. Humpback whales are not found in the Ross Sea, where both Antarctic krill and ice krill (*E. crystallorophias*) are available, and where the authors found no change in prey availability for Antarctic minke whales.

These studies suggested a decrease in the availability of krill for Antarctic minke whales.

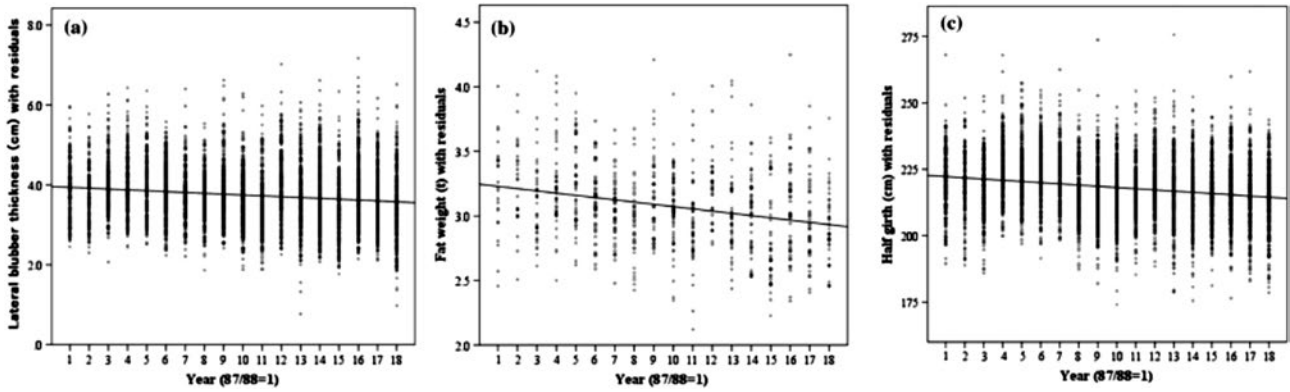

Figure 13. Yearly trends in blubber thickness (a), fat weight (b) and girth (c) in Antarctic minke whale in the Indo-Pacific region of the Antarctic from 1987/88 to 2004/05 (after Konishi *et al.*, 2008).

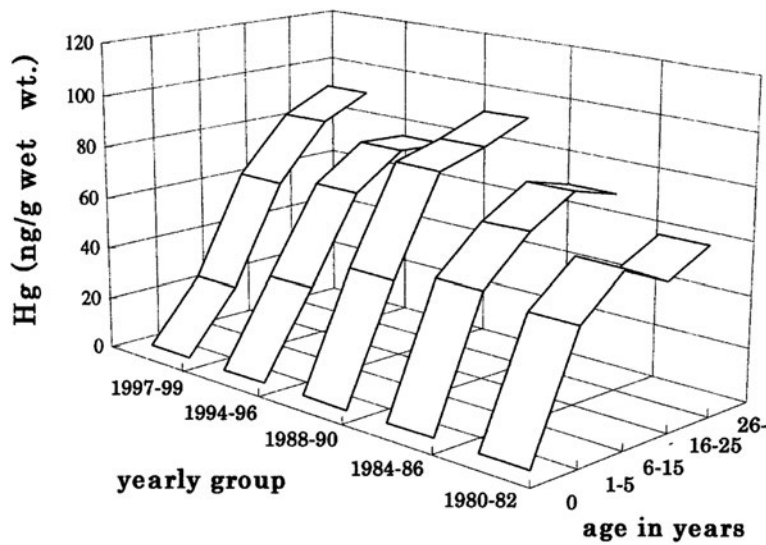

Figure 14. Yearly age-related changes of hepatic Hg concentrations in the Antarctic minke whale (after Honda *et al.*, 2006).

Pollutant loads

Honda *et al.* (2006) studied yearly age-related accumulations of Hg in the Antarctic minke whales collected in the period 1980–1999 in the Indo-Pacific region. One of the relevant results was that of Hg levels and growth rates in young age-groups (1–5 years old): Hg levels and body weights for the 1997/99 season groups were significantly lower than those for the 1988/90 groups. On the other hand they examined the Hg levels in krill from the whale stomach, and no yearly significant differences were found. They concluded that the differences in Hg levels in younger age groups was due to differences in the amount of food intake by the whale i.e. whale are consuming less food in recent years (Figure 14). These results are consistent with the decrease in stomach contents weight in Antarctic minke whales in recent years.

Demographic parameters

As shown in Figure 5 the age at sexual maturity for Ant-

arctic minke whales has stabilized or slightly increased since the 1970’s and 1980’s. The recruitment has consistently been broadly stable since the 1970’s and the total abundance estimated by SCAA has been stable or slightly decreasing (Figure 6). These observations are consistent with the observation of deteriorated nutritional conditions since the 1980’s.

Other species

A recent study showed that the regional population of the krill-eater Adelie penguin have almost doubled in abundance since the 1980’s and have been increasing since the earliest counts in the 1960’s. These results of decadal-scale change were based on a combination of extensive new population survey data, new population estimation methods, and re-interpretation of historical survey data (Southwell *et al.*, 2015).

Summary

Evidence available since the 1980's has shown that the nutritional conditions for Antarctic minke whales have not been optimal as revealed by the decrease in energy storage and stomach content weight since the 1980's. This observation is consistent with the observations that age at sexual maturity has stabilized or slightly increased in the 1970's and that the recruitment was stable after 1970. The stable trend in recruitment is consistent with the total abundance of Antarctic minke whale estimated by sighting data which has been broadly stable since the 1980's.

The observations above suggest less availability of krill for Antarctic minke whales. Less availability of krill for this species could result from competition with other recovering krill-eater large whale species, e.g. the reversal of Laws' 'krill surplus' hypothesis. The implication of these 'deteriorated' nutritional conditions is the possibility of a decrease of Antarctic minke whale abundance in the near future.

Southwell *et al.* (2015) provided two explanations for the increase of the Adelie penguins in East Antarctica. The first was that harvesting of baleen whales, krill and fish across East Antarctic waters through the 20th century could have reduced competition between Adelie penguins and other predators for food, and improved prey availability. The second was that a proposed reduction in sea-ice extent in the mid-20 century may also have benefited Adelie penguins by enabling better access to the ocean for foraging. Since a strong recovery of krill-eater large baleen whales has been reported since the 1980's, it can be suggested that environmental factors are more plausible for explaining the increase of Adelie penguins since the 1980's. Probably environmental changes have stronger effects on land-based predators such as the penguins than on sea-based predators such as whales.

CONCLUDING REMARKS

The review of scientific evidence for ecosystem changes in the Indo-Pacific region of the Antarctic has highlighted the importance of long-time monitoring research programs focused on the collection of biological data of krill predators (land-based and sea-based predators) as well as data on sea ice cover and environmental variables. Evidence of environmental changes are more marked in West Antarctic than East Antarctic. An implication of this is that in East Antarctic (Indo-Pacific region), competition for space and food could better explain the pattern of changes in biological and demographic parameters observed among sea-based krill predators. However to

further investigate the plausibility of this hypothesis it will be necessary to obtain information on krill biomass trends in the research area. There is some partial information based on dedicated krill surveys in the past but the information is scattered and needs to be combined with new surveys in a comprehensive and consistent way so that time series data can be obtained.

ACKNOWLEDGEMENTS

We thank researchers and crew members of the JARPA/JARPAII and IDCR/SOWER surveys that collected samples and data used in many published studies, on which this review is based.

REFERENCES

- Allen, K.R. 1980. *Conservation and Management of Whales*. Washington Sea Grant Publication, Washington and Butterworths, London, 107 pp.
- Bando, T., Kishiro, T. and Kato, H. 2014. Yearly trend in the age at sexual maturity of Antarctic minke whales by transition phase in earplugs collected during JARPA and JARPAII surveys. Paper SC/65b/IA1 presented to the IWC Scientific Committee, May 2014 (unpublished). 12 pp. [Available from the IWC Secretariat].
- Branch, T.A. and Butterworth, D.S. 2001. Estimates of abundance south of 60°S for cetacean species sighted frequently on the 1978/79 to 1997/98 IWC/IDCR-SOWER sighting surveys. *J. Cetacean Res. Manage.* 3 (3): 251–270.
- Branch, T.A., Matsuoka, K. and Miyashita, T. 2004. Evidence for increases in Antarctic blue whales based on Bayesian modelling. *Mar. Mam. Sci.* 20 (4): 726–754.
- Buckland, S.T., Rexstad, E.A., Marques, T.A. and Oedekoven, C.S. 2015. *Distance sampling: Methods and applications*. Springer, Cham. 270 pp.
- Fraser, W.R., Trivelpiece, W.Z., Ainley, D.G. and Trivelpiece, S.G. 1992. Increases in Antarctic penguin populations: reduced competition with whales or a loss of sea ice due to environmental warming? *Polar Biol.* 11: 525–531.
- Hakamada, T., Matsuoka, K., Nishiwaki, S. and Kitakado, T. 2013. Abundance estimates and trends for Antarctic minke whales (*Balaenoptera bonaerensis*) in Antarctic Areas IV and V based on JARPA sighting data. *J. Cetacean Res. Manage.* 13 (2): 123–151.
- Honda, K., Aoki, M. and Fujise, Y. 2006. Ecochemical approach using mercury accumulation of Antarctic minke whale, *Balaenoptera bonaerensis*, as tracer of historical change of Antarctic marine ecosystem during 1980–1999. *Bull. Environ. Contam. Toxicol.* 76: 140–147.
- International Whaling Commission. 2012. Requirements and guidelines for conducting surveys and analyzing data within the Revised Management Scheme. *J. Cetacean Res. Manage.* 13 (Suppl.): 509–516.

- International Whaling Commission. 2013. Report of the Scientific Committee. *J. Cetacean Res. Manage.* 14 (Suppl.): 1–102.
- Konishi, K., Tamura, T., Zenitani, R., Bando, T., Kato, H. and Walløe, L. 2008. Decline in energy storage in the Antarctic minke whale *Balaenoptera bonaerensis* in Southern Ocean. *Polar Biol.* 31: 1509–1520.
- Konishi, K., Hakamada, T., Kiwada, H., Kitakado, T. and Walløe, L. 2014. Decrease in stomach contents in the Antarctic minke whale (*Balaenoptera bonaerensis*) in the Southern Ocean. *Polar Biol.* 37: 205–215.
- Laws, R.M. 1977. Seals and whales of the Southern Ocean. *Philos. Trans. R. Soc. Lond. B* 279: 81–96.
- Laws, R.M. 1985. The Ecology of the Southern Ocean. *Am. Sci.* 73: 26–40.
- Matsuoka, K., Hakamada, T., Kiwada, H., Murase, H. and Nishiwaki, S. 2005. Abundance increases of large baleen whales in the Antarctic based on the sighting survey during Japanese Whale Research Program (JARPA). *Global Environ. Res.* 9 (2): 105–115.
- Matsuoka, K., Hakamada, T., Kiwada, H., Murase, H. and Nishiwaki, S. 2011. Abundance estimates and trends for humpback whales (*Megaptera novaeangliae*) in Antarctic Areas IV and V based on JARPA sightings data. *J. Cetacean Res. Manage.* (Special Issue 3): 575–594.
- Murase, H., Matsuoka, K., Hakamada, T. and Kitakado, T. 2014. Preliminary analysis of changes in spatial distribution of Antarctic minke and humpback whales in Area IV during the period of JARPA and JARPAII from 1989 to 2006. Paper SC/F14/J18 presented to the IWC/SC Review Workshop of the Japanese Whale Research Program under Special Permit in the Antarctic-Phase II (JARPAII), February 2014 (unpublished). 17 pp. [Available from the IWC Secretariat].
- Nicol, S. 2006. Krill, currents, and sea ice: *Euphausia superba* and its changing environment. *BioScience* 56 (2): 111–120.
- Pastene, L.A., Fujise, Y. and Hatanaka, H. 2014. The Japanese Whale Research Program under Special Permit in the Antarctic-Phase II (JARPAII): origin, objectives, research progress made in the period 2005/06-2010/2011 and relevance for management and conservation of whales and the ecosystem. Paper SC/F14/J1 presented to the IWC/SC Review Workshop of the Japanese Whale Research Program under Special Permit in the Antarctic-Phase II (JARPAII), February 2014 (unpublished). 76 pp. [Available from the IWC Secretariat].
- Punt, A.E. 2014. A summary history of the application of statistical catch-at-age analysis (SCAA) to Antarctic minke whales. *J. Cetacean Res. Manage.* 14: 81–92.
- Punt, A.E., Hakamada, T., Bando, T. and Kitakado, T. 2014. Assessment of Antarctic minke whales using statistical catch-at-age analysis (SCAA). *J. Cetacean Res. Manage.* 14: 93–116.
- Sahrhage, D. 1984. Present knowledge of living marine resources in the Antarctic, possibilities for their exploitation and scientific perspectives. In: R. Wolfrum (Ed): Antarctic Challenge, Conflict of Interests, Cooperation, Environmental Protection, and Economic Development. Duncker and Humblot / Berlin. 66–88 pp.
- Southwell, C., Emmerson, L., McKinlay, J., Newbery, K., Takahashi, A., Kato, A., Barbraud, C., DeLord, K. and Weimerskirch, H. 2015. Spatially extensive standardized surveys reveal widespread, multi-decadal increase in East Antarctic Adelie penguin populations. *Plos ONE* 11 (10): e0165989.
- Thomson, R.B., Butterworth, D.S. and Kato, H. 1999. Has the age at transition phase of southern hemisphere minke whales declined over recent decades? *Mar. Mamm. Sci.* 15 (3): 661–682.
- Trivelpiece, W.Z., Hinke, J.T., Miller, A.K., Reiss, C.S., Trivelpiece, S.G. and Watters, G.M. 2011. Variability in krill biomass links harvesting and climate warming to penguin population changes in Antarctica. *PNAS* 108 (18): 7625–7628.

Technical Report (not peer reviewed)

An overview of the Institute of Cetacean Research work on ecosystem modeling in the Antarctic and western North Pacific

Takashi HAKAMADA* and Tsutomu TAMURA

Institute of Cetacean Research, 4–5 Toyomi-cho, Chuo-ku, Tokyo 104–0055, Japan

*Contact e-mail: hakamada@cetacean.jp

ABSTRACT

The development of ecosystem models has been an important research activity organized and promoted by the Institute of Cetacean Research (ICR). This paper presents an overview of the objectives and progress made in the research on ecosystem modeling in the Antarctic and western North Pacific. Whale abundance, prey composition and prey consumption of whales have been some of the input data to the models, which were obtained by ICR surveys. Several future research needs to progress the ecosystem modeling work have been identified.

INTRODUCTION

The development of ecosystem models has been an important research activity of the Institute of Cetacean Research (ICR) in its whale research programs in the Antarctic and western North Pacific. What is understood by ‘ecosystem models’? An ecosystem model is an abstract, usually mathematical representation of an ecological system, which is studied to better understand the real system (Hall and Day, 1990). Ecological relationships, such as the relation between predators and preys, are derived using data gathered from the field, and these are combined to form ecosystem models. These model systems are studied in order to make predictions about the dynamics of the real system.

Ecosystem models have applications in a wide variety of disciplines including natural resource management. Morishita (2008) provided a good summary of the various interpretations of the ecosystem approach for fisheries management, one of them being the evolution from single-species management to multi-species management. According to the FAO home page (Fisheries and Aquaculture Department), ecosystem models for fisheries management purposes have ranged in complexity from enhanced single-species models to fully articulated food web models including physiological, spatial and environmental processes.

Objectives of ecosystem modeling studies are different according to the kind of model used. They could be, for example, 1) understanding structure, features and interactions of an ecosystem, 2) identifying major causes

of changes in an ecosystem, 3) prediction of population dynamics for specific species, 4) assessment of the impact of fisheries and predation on an ecosystem, 5) providing some scientific advice on management of a stock or stocks.

Plagányi (2007) reviewed ecosystem modeling studies and grouped the models into two groups: 1) whole ecosystem models, which are models taking into account all trophic levels. This includes Ecopath with Ecosim (EwE) (Christensen *et al.*, 2005); and 2) Minimum Realistic Models (MRM), which are models restricted to represent a limited number of species most likely to have important interactions with a target species of interest. This includes MULTSPEC (Bogstad *et al.*, 1997; Tjelmeland and Bogstad, 1998) and BORMICON (Stefansson and Palsson, 1998).

This paper summarizes the studies on ecosystem modeling organized and promoted by the ICR in the Antarctic and western North Pacific Ocean.

ECOSYSTEM MODELING IN THE ANTARCTIC

Background

The ecological background for the ecosystem modeling in the Antarctic is provided by Fujise and Pastene (this issue). There are some hypotheses related to ecosystem changes in the Antarctic. The first is referred to as the ‘krill surplus’ hypothesis. After the depletion of Antarctic blue (*Balaenoptera musculus intermedia*), fin (*B. physalus*) and humpback (*Megaptera novaeangliae*) whales at the middle of the past century there was some 150 million tons of krill surplus. This surplus became available

for other krill-eater species of penguins, seals and smaller whales (e.g. Antarctic minke whale, *B. bonaerensis*) (Laws, 1977). The krill surplus implied better nutritional conditions in those species, which was reflected in changes in some demographic parameters. For example from 1940 to 1970, recruitment had been increasing for Antarctic minke whales (Punt *et al.*, 2014) reflecting better nutritional conditions for the species at the middle of the past century.

The second hypothesis is that the population dynamics of Antarctic species is affected by environmental changes. A decrease in sea-ice cover by the middle of the twenty-first century due to global warming has been predicted by several studies (Levitus *et al.*, 2000; de la Mare, 1997). Warming of the Southern Ocean appears to be occurring faster than the warming of other oceans of the world (Gille, 2002).

It was therefore necessary to investigate and quantify the interactions among krill predators such as some baleen whale species, and to examine the dynamics of the Antarctic marine ecosystem. This would enable investigation of what has happened in the past and to predict what is going to happen in the future in the context of ecosystems in the Antarctic (GOJ, 2015). For this aim, ecosystem modeling has been used.

One of the main objective of the ecosystem modeling study in the Antarctic was to determine whether predator-prey interactions alone can broadly explain observed population trends without the need for recourse to environmental change hypotheses (Mori and Butterworth, 2006).

MRM Models in the Antarctic

Objectives

The objective of the study by Mori and Butterworth (2006) was to determine whether predator-prey interactions alone can broadly explain the observed population trends of four large baleen whale species, Antarctic blue, fin, humpback and Antarctic minke whales; two seal species, Antarctic fur seal (*Arctocephalus gazelle*) and crabeater seal (*Lobodon carcinophagus*); and Antarctic

krill (*Euphausia superba*), without the need for recourse to environmental change hypotheses.

Ecosystem model

Population dynamics models were developed to describe predator-prey interactions among the four large baleen whale species, the two seals species and krill (Figure 1). Functional responses are generally classified into three types, which are called Type I, II, and III (Holling, 1959). In the model, two types of functional responses were considered, Type II, which assumes that consumption rate decreases as prey abundance increases and that prey consumption is limited, and Type III, which assumes that consumption rate increases as prey abundance increases when prey abundance is lower than a threshold of prey abundance, and it decreases as prey abundance increases when prey abundance is higher than the threshold (Holling, 1959). Mori and Butterworth (2006) fitted the abundance estimates of these species to estimate parameters/coefficients in the models by maximum likelihood method.

Research area and data used

The predator-prey model was constructed in two sectors of the Antarctic. One in the Atlantic/Indian sector (east of 60°W and west of 130°E) and the other in the Pacific sector (east of 130°E and west of 60°W). Historical catch data for all species considered in the model were used. Abundance estimates of krill predators for the whole sectors were also used. Abundance trend estimates for blue, humpback, Antarctic minke whales and crabeater seal were made for a part of each sector, and were based on independent data sources.

Results

The main results of Mori and Butterworth (2006) were the following:

- (i) species interaction effects alone can explain observed predator abundance trends;
- (ii) it is necessary to consider species other than baleen whales and krill, to explain observed trends—

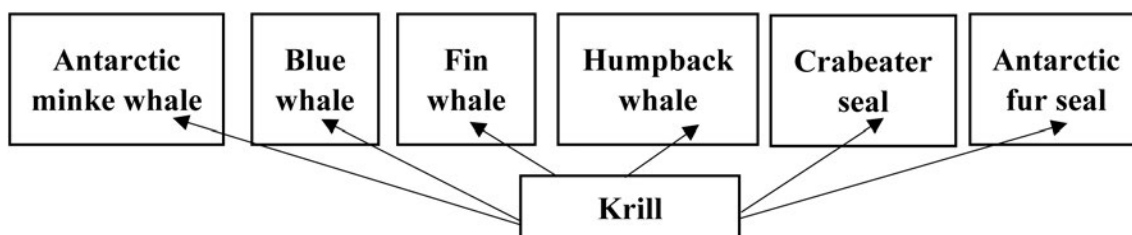

Figure 1. Food web in the Antarctic modeled in Mori and Butterworth (2006) and Moosa (2017).

crabeater seals seemingly play an important role and constitute a particular priority for improved abundance and trend information;

- (iii) the Atlantic/Indian Ocean sector shows major changes in species abundances, in contrast to the Pacific Ocean sector, which is much more stable;
- (iv) baleen whales have to be able to achieve relatively high growth rates to explain observed trends; and
- (v) Laws (1977) estimate of some 150 million tons for the krill surplus may be too high because his calculations omitted consideration of density-dependent effects in feeding rates.

Moosa (2017) refined the ecosystem modeling work by Mori and Butterworth (2006), mainly by incorporating/ updating catch history and abundance estimates of species considered in the model, and by making some technical improvement to the model. Preliminary results supported the main findings of Mori and Butterworth (2006).

Moosa (2017) identified the following future work required: i) inclusion of a space limitation term for the fur seals in the model so as not to increase their population to unrealistically high values; ii) consideration of a set of differently defined regions as this might possibly better represent the Antarctic minke whale abundance trends and population trajectories; iii) further consideration of the variation of the effective annual natural mortality rate of krill, because this is likely causing the oscillations in the krill dynamics; iv) further consideration of the variation of the bounds imposed on carrying capacity of krill; and v) further consideration of the variation in the proportion of fin whales assumed to feed south of 60°S.

This work is ongoing.

ECOSYSTEM MODELING IN THE WESTERN NORTH PACIFIC

Background

There were two main motivations for building ecosystem models in the western North Pacific. The first one was the rapid decrease of Japan's fisheries catch from 12,785 thousand tons in 1988 to 4,690 thousand tons in 2015 (GOJ, 2000; 2017). Ecosystem models including fishery resources can provide some insight to the reasons for changes in stock status considering interaction among species.

The second one was the possibility of competition between marine mammals and fisheries on prey species of economic importance. For example, common minke whales (*Balaenoptera acutorostrata*) sightings occurred close to the fishing grounds of Pacific saury (*Cololabis saira*) off Kushiro. In fact, they fed mainly on Pacific saury

near the fishing ground of the Pacific saury. This observation suggested a relationship between common minke whales and Pacific saury from summer to autumn in the western North Pacific (Tamura and Fujise, 2002). Ecosystem models can be used to investigate whether competition exists, for example by comparing ecosystem models with and without the assumption of competition.

EwE model in the western North Pacific

Objectives

Mori *et al.* (2009) applied the EwE model to investigate the possible impact of whaling on the catch of other species in the western North Pacific ecosystem. They also compared single-species MSY and multi-species MSY. If there were substantial differences between the two MSYs, the stock status derived from the two models could be quite different. In such a situation, multi-species model should be used rather than single-species model for assessment of the stocks.

Ecosystem model used

Ecopath is a static, mass-balanced snapshot of the system and Ecosim is a time dynamic simulation module for policy exploration (Christensen *et al.*, 2005). The model consist of the species from detritus to top predators. Ecopath is used to model trophic flow within a food chain of an ecosystem. Ecosim can be used to simulate temporal change from the steady state described by the Ecopath model under some harvesting scenarios.

The scenarios examined in Mori *et al.* (2009) were: i) harvesting 4% of the common minke whale population; ii) harvesting 4% of the sei whale (*B. borealis*) population; iii) harvesting 4% of Bryde's whale (*B. edeni*) population; iv) harvesting 4% of the common minke, sei and Bryde's whale populations; v) harvesting 4% of the sperm whale (*Physeter macrocephalus*) population; and vi) harvesting 4% of the four whale species.

For an initial test run, the impact of no harvesting and harvesting 4% of the whales for the coming 50 years on catch of the fishes, was made. Uncertainty of the data input to Ecopath, functional response and trophic flow (top-down or bottom-up) were considered. Type I functional response, which assumes that prey consumption is in proportion to prey abundance up to the maximum (Holling, 1959) was assumed as the reference case, and the Types II and III functional responses were used for sensitivity analyses.

Research area and data used

Mori *et al.* (2009) developed the EwE in the western

Table 1

List of the species/groups used in the EwE model and Trophic Level (TL) estimated by Ecopath (Mori *et al.*, 2009).

Species/Group	TL	Species/Group	TL	Species/Group	TL
Minke whale	3.99	Albacore	4.08	Pacific pomfret	4.20
Bryde's whale	3.83	Sword fish	4.81	Sardine	2.30
Sei whale	3.73	Skipjack tuna	3.97	Anchovy (<8 cm)	3.04
Other baleen whales	3.23	Blue shark	4.27	Anchovy (\geq 8 cm)	3.04
Sperm whale	4.17	Salmon shark	4.35	Pacific saury	3.12
Baird's beaked whale	4.15	Lanternfish	3.06	Phytoplankton	1.00
Short-finned pilot whale	4.40	Neon flying squid	4.12	Euphausiids	2.18
Ziphiidae	4.24	Large surface squid	3.41	Copepods eaten by whales	2.00
Other toothed whales	4.46	Small surface squid	3.01	Other Copepods	2.00
Northern fur seal	4.08	Mid-deep water sea squid	3.11	Detritus	1.00
Marine birds	4.24	Mackerels	3.30		

North Pacific (north of 35°N and west of 170°E), where JARPNII surveys were conducted. The model consists of 32 species/groups ranging from detritus to whales (Table 1). Estimated trophic level (TL) for each species is shown in Table 1. Higher TL represents the species playing a role closer to top predator in the ecosystem. Input data required for the model were biomass, production, prey consumption, diet composition and total fishery catch of each predator in the target area. When production is not available, total mortality was used in the Ecopath instead of production per biomass (Christensen *et al.*, 2005).

Biomass, prey consumption and diet compositions for common minke, Bryde's, sei and sperm whales were based on JARPNII surveys. Details of the input data were provided in Mori *et al.* (2009). Once the mass-balance model was constructed, possible effect on fisheries of the species in the model were simulated by using Ecosim under the harvesting scenarios examined.

Results

Results of Mori *et al.* (2009) suggested the following:

- i) when minke whales are the only species that are harvested by 4% of its biomass (catch of other species are kept constant at current catch rate), depending on the functional response form assumed for the species, it is not certain whether catch of some Japanese fisheries resources (*e.g.* anchovy (*Engraulis japonicus*), Pacific saury, skipjack tuna (*Katsuwonus pelamis*), mackerels (*Scomber japonicus*, *S. australasicus*) will increase or not;
- ii) when sei and Bryde's whales are each the only species that are harvested by 4% of their biomass, regardless of the functional response form assumed for the species, catch of anchovy, skipjack tuna, and mackerels may increase;

- iii) when minke, sei and Bryde's whales are all harvested by 4% of their biomass, an increase in catch is expected for most of the fish resources (*i.e.* anchovy, skipjack tuna and mackerels), indicating the effectiveness of harvesting several whale species simultaneously; and
- iv) when sperm whales are the only species that are harvested by 4% of its biomass, depending on the functional response form assumed for the species, catch of anchovy, Pacific saury, mackerels and skipjack tuna may decrease, but in contrast, catch of neon-flying squid may increase.

The work by Mori *et al.* (2009) is being updated in the studies by Murase *et al.* (2016) and Watari *et al.* (2018). Murase *et al.* (2016) have focused on the interactions between forage fish and their predators including target species of JARPNII (common minke, sei, Bryde's and sperm whales). They have updated the input data to the models by considering the data available in the period 1994–2013 and made several technical improvements following recommendations from the International Whaling Commission Scientific Committee (IWC SC). Watari *et al.* (2018) have improved Ecopath model focusing on the small pelagic fishes to investigate their role in the ecosystem by using two ecological indices.

Murase *et al.* (2016) and Watari *et al.* (2018) have identified several future data and work required to progress the development of ecosystem modeling in the western North Pacific. Some suggestions to improve input of EwE were the following: (i) consistency of spatial resolution of input data is required, (ii) regional models are to be developed within the EwE area, (iii) collection of diet composition data at regular interval is required because some of the diet composition data were old or obtained outside the research area, (iv) resolution (the numbers

of species/group) and quality of data on non-commercial and lower trophic level species should be improved and (v) evaluation of the sensitivity of Ecopath models to input data is required.

This work is ongoing.

MRM in coastal areas

Objectives

Okamura *et al.* (2009) examined the effects of predation of common minke whales on sandlance (*Ammodytes* spp.) stock off Sanriku region to investigate the effect of predation by the common minke whales in terms of MSY of the sandlance population.

Model used

A Bayesian delay-difference approach (Hilborn and Walters, 1992; Meyer and Miller, 1999) was used to develop a MRM-type ecosystem model. They focused on interaction between sandlance and common minke whales (Figure 2), and constructed a population dynamics model of sandlance taking into account predation by the common minke whales. In the analysis, functional response Types I, II and III (Holling, 1959) were considered.

Research area and data used

The research area was the coastal area off Sanriku. Data used in this modeling were CPUE series of juvenile and adult sandlance fisheries, abundance estimate for adult sandlance, age, length and weight time series of sandlance during 1999–2005, catch series of sandlance by lift net with light fishery, dip nets, and trawl-net fishery from 1901 to 2006 and stomach contents of the common minke whales off Sanriku in 2003 obtained from JARPNII surveys (Tamura *et al.*, 2004).

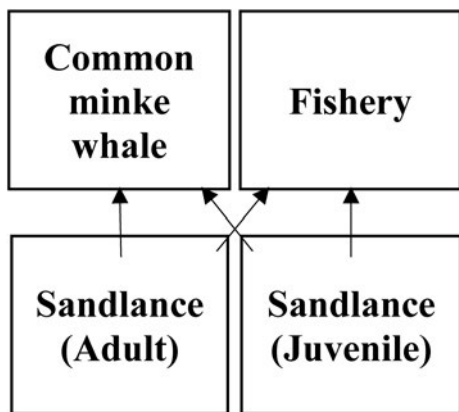

Figure 2. Ecosystem model off Sanriku modeled in Okamura *et al.* (2009) and Kitakado *et al.* (2016).

Results

Under the scenarios of the linear functional response curve (Type I), the resultant impact was so great that the median value of MSY was increased by 154%. Whereas using the constant functional response scenario (most extreme functional form), the impact was much smaller, where there was only a 17% increase of the median value of MSY. This suggested that estimating functional response is important to assess the impact of predation by the common minke whales.

Kitakado *et al.* (2016) updated the model work by Okamura *et al.* (2009) by using new data as follows: i) catch and CPUE series of juvenile sandlances by lift nets with light fishery (1994–2015); ii) catch and CPUE series of adult sandlances by dip nets fishery (1994–2015); iii) time series of age composition data of sandlances taken from summer sampling survey (2002–2014); iv) time series of density estimate of sandlances (in number) during summer sampling survey (2002–2014); v) consumption of sandlances by common minke whales in 2005, 2006 and 2012 (JARPNII surveys); and vi) time series of abundance estimates in Sanriku region for the common minke whales in 2004, 2005, 2006 and 2012.

Further analyses should be conducted to examine sensitivities of the results to the assumption of prior distributions. Because only the Type II functional response was assumed in Kitakado *et al.* (2016), other forms of functional response and multiple-prey functional response with krill and anchovy are worthy to investigate. The weight allocated among the components of the likelihood (likelihood relevant to abundance of juvenile sandlance, likelihood relevant to abundance of adult sandlance, and likelihood relevant to age composition of sandlance) should be carefully considered in future analyses (Kitakado *et al.*, 2016).

This work is ongoing.

CONCLUDING REMARKS

Progress has been made in the development of ecosystem modeling for some particular objectives related to fisheries management and ecosystem structure and dynamics, in both the Antarctic and western North Pacific. Biological and abundance data of the species considered in the models are important. In the case of whale species such data came from ICR surveys. Several research needs were identified which should be addressed to progress the work on ecosystem modeling work and potentially contribute to resources management taking into account multi-species considerations.

REFERENCES

- Bogstad, B., Hauge, K.H. and Ulltang, O. 1997. MULTSPEC: a multi-species model for fish and marine mammals in the Barents Sea. *J. N. Atl. Fish. Sci.* 22: 317–341.
- Christensen, V., Walters, C.J. and Pauly, D. 2005. Ecopath with Ecosim: a user's guide. Fisheries Center, University of British Columbia, Vancouver.
- de la Mare, W.K. 1997. Abrupt mid-twentieth-century decline in Antarctic sea-ice extent from whaling records. *Nature* 389: 57–60.
- Gille, S.T. 2002. Warming of the Southern Ocean since the 1950s. *Science* 295: 1275–1277.
- Government of Japan. 2000. Research plan for cetacean studies in the western North Pacific under special permit (JARPNII) (Feasibility study plan for 2000 and 2001). Paper SC/52/O1 presented to the IWC Scientific Committee, June 2000 (unpublished). 68 pp. [Available from the IWC Secretariat].
- Government of Japan. 2015. Research Plan for New Scientific Whale Research Program in the Antarctic Ocean (NEWREP-A). IWC.ALL.238, November 2015 (unpublished). 110 pp.
- Government of Japan. 2017. Annual Statistics of Fishery and Fish Culture 2015. Statistics Department of Ministry of Agriculture, Forestry and Fisheries. 53 pp. (in Japanese).
- Hall, C.A.S. and Day, J.W. 1990. Ecosystem Modeling in Theory and Practice: An Introduction with Case Histories. University Press of Colorado. 684 pp.
- Hilborn, R. and Walters, C.J. 1992. Quantitative Fisheries Stock Assessment. Chapman and Hall, London. xv+570 pp.
- Holling, C. 1959. The Components of Predation as Revealed by a Study of Small-Mammal Predation of the European Pine Sawfly. *The Canadian Entomologist* 91 (5): 293–320.
- Kitakado, T., Murase, H. and Tamura, T. 2016. Predation impacts on sandlance population by consumption of common minke whales off Sanriku region. Paper SC/F16/JR29 presented to JARPNII final review meeting. February 2016 (unpublished) 10 pp. [Available from the IWC Secretariat].
- Laws, R.M. 1977. Seals and whales of the Southern Ocean. *Phil. Trans. R. Soc. Lond. B* 279: 81–96.
- Levitus, S., Antonov, J.I., Boyer, T.P. and Stephens, C. 2000. Warming of the world ocean. *Science* 287: 2225–2229.
- Meyer, R. and Millar, R.B. 1999. Bayesian stock assessment using a state-space implementation of the delay difference model. *Canadian Journal of Fisheries and Aquatic Sciences* 56: 37–52.
- Moosa, N. 2017. An updated model of the krill-predator dynamics of the Antarctic ecosystem. MSc thesis, University of Cape Town. 246 pp.
- Mori, M. and Butterworth, D.S. 2006. A first step towards modelling the krill–predator dynamics of the Antarctic ecosystem. *CCAMLR Science* 13: 217–277.
- Mori, M., Watanabe, H., Hakamada, T., Tamura, T., Konishi, K., Murase, H. and Matsuoka, K. 2009. Development of an ecosystem model of the western North Pacific. Paper SC/J09/JR21 presented to JARPNII review meeting, January 2009 (unpublished) 49 pp. [Available from the IWC Secretariat].
- Morishita, J. 2008. What is the ecosystem approach for fisheries management? *Marine Policy* 32: 19–26.
- Murase, H., Tamura, T., Hakamada, T., Watari, S., Okazaki, M., Kiyofuji, H., Yonezaki, S. and Kitakado, T. 2016. Ecosystem modelling in the western North Pacific from 1994 to 2013 using Ecopath with Ecosim (EwE): some preliminary results. Paper SC/F16/JR28 presented to JARPNII final review meeting. February 2016 (unpublished). 69 pp. [Available from the IWC Secretariat].
- Okamura, H., Nagashima, H. and Yonezaki, S. 2009. Preliminary assessment of impacts on the sandlance population by consumption of minke whales off Sanriku region. Paper SC/J09/JR14 presented to JARPNII review meeting, January 2009 (unpublished). 20 pp. [Available from the IWC Secretariat].
- Plangáyi, E.E. 2007. Models for an ecosystem approach to fisheries. *FAO Fisheries Technical paper* 477. Rome, FAO. 108 p.
- Punt, A.E., Hakamada, T., Bando, T. and Kitakado, T. 2014. Assessment of Antarctic minke whales using statistical catch-at-age analysis (SCAA). *J. Cetacean Res. Manage.* 14: 93–116.
- Stefansson, G. and Palsson, O.K. 1998. A framework for multi-species modelling of boreal systems. *Reviews in Fish Biology and Fisheries* 8: 101–104.
- Tamura, T. and Fujise, Y. 2002. Geographical and seasonal changes of prey species of minke whale in the Northwestern Pacific. *ICES Journal of Marine Science* 59: 516–528.
- Tamura, T., Konishi, K., Miyashita, T., Yoshida, H., Kato, H. and Kawahara, S. 2004. Preliminary analyses of interaction between common minke whales and sand lance fisheries off Sanriku region. Paper SC/56/O17 presented to the IWC Scientific Committee meeting, June 2004 (unpublished). 9 pp. [Available from the IWC Secretariat].
- Tjelmeland, S. and Bogstad, B. 1998. MULTSPEC—a review of a Multi-species modelling project for the Barents Sea. *Fish. Res.* 37: 127–142.
- Watari, S., Murase, H., Yonezaki, S., Okazaki, M., Kiyofuji, H., Tamura, T., Hakamada, T., Kanaji, Y. and Kitakado, T. 2018. Ecosystem modeling in the western North Pacific using Ecopath, with a focus on small pelagic fishes. *Mar. Ecol. Prog. Ser.* <https://doi.org/10.3354/meps12508>.

Technical Report (not peer reviewed)

Geographical distribution of whales in the Indo-Pacific region of the Antarctic based on JARPA and JARPAII sighting data collected in the period 1987/88–2008/09

Koji MATSUOKA* and Takashi HAKAMADA

Institute of Cetacean Research, 4–5 Toyomi-cho, Chuo-ku, Tokyo 104–0055, Japan

*Contact e-mail: matsuoka@cetacean.jp

ABSTRACT

This paper examined the geographical and temporal pattern of distribution of several whale species in the Indo-Pacific region of the Antarctic during the austral summer. The analyses were based on sighting data collected systematically by JARPA and JARPAII surveys in the longitudinal sector 35°E–145°W, south of 60°S, between 1987/88 and 2008/09. A total of 353,134 n.miles was surveyed in these Areas. Density Index of Whales (No. of individuals sighted/100 n.miles) was calculated and its geographical distribution plotted for each individual species. Antarctic minke whale was the species most frequently sighted, followed by killer, humpback, unidentified beaked, fin, sperm, southern bottlenose, blue, southern right and sei whales. The geographical pattern of distribution was described for each whale species. The large sighting data set collected systematically by JARPA and JARPAII in the Indo-Pacific region has made a substantial contribution to understanding the pattern of geographical distribution and habitat use of whales in the Antarctic ecosystem.

INTRODUCTION

One of the main sources of sighting data for assessing the population status of whale species in the Antarctic is the JARPA which was conducted between 1987/88 and 2004/05, and its second phase JARPAII conducted between 2005/06 and 2008/09.

The sighting data collected during the JARPA have been used for studying the distribution pattern and abundance estimation of several large whale species (Kishino *et al.*, 1991; Kasamatsu *et al.*, 2000; Matsuoka *et al.*, 2003; 2011; Branch *et al.*, 2004; Murase *et al.*, 2002; 2014).

The objective of this study was to investigate the pattern of geographical distribution of large whale species in the Indo-Pacific region of the Antarctic during the austral summer feeding season. The study was based on sighting data collected systematically by JARPA and JARPAII surveys.

MATERIAL AND METHODS

Research area

The research area comprised the Indo-Pacific region of the Antarctic, specifically the International Whaling Commission (IWC) Management Areas III E (35°E–70°E),

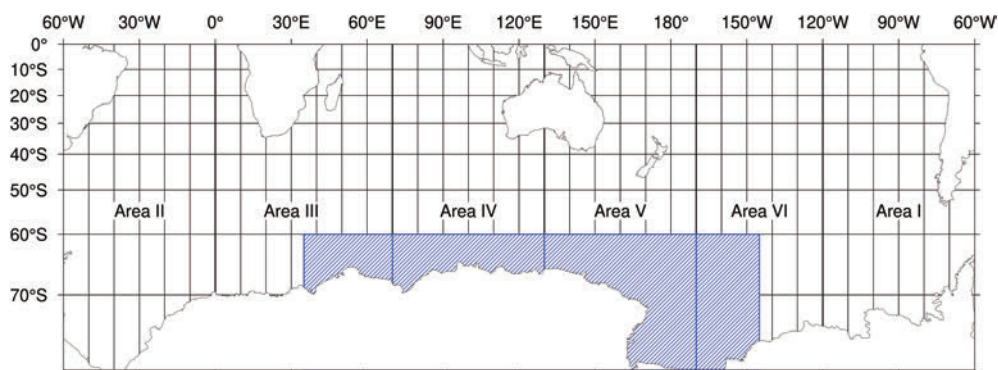

Figure 1. The IWC Antarctic Areas for the management of baleen whales (except Bryde's whale), and the research Area of the JARPA and JARPAII surveys between 35°E and 145°W.

IV (70°E–130°E), V (130°E–170°W) and VIW (170°W–145°W), south of 60°S (Figure 1).

Sighting data

Primary sighting and effort data were collected by JARPA and JARPAIL systematic surveys in the period 1987/88–2008/09. Surveys were conducted by sighting and sampling vessels (SSV) and dedicated sighting vessels (SV).

Sighting procedure

The sighting procedure in JARPAIL (2005/06–2008/09) was not substantially changed with regard the procedures in JARPA (Nishiwaki *et al.*, 2014). The research vessels were equipped with top barrel, where three top men conducted sightings. On the upper bridge, a captain, a gunner, a helmsman and a researcher also conducted the sighting. The sighting activity was conducted under acceptable weather conditions (see below), from 30 minutes after sunrise to 30 minutes before the sunset.

Survey modes

Searching was conducted under closing and passing modes (Hakamada *et al.*, 2006). These modes were used under acceptable weather conditions (minke whale visibility of 2 n.miles or more and wind speed under 20 knots in the northern strata, and under 25 knots in the southern strata) (Nishiwaki *et al.*, 2014).

Confirmation of the sightings

When a sighting was made, the vessel closed to the school immediately in order to identify the species, estimate the school size and get other biological information

(number of calves, estimated body length, etc.).

Density Index of Whales

The Density Index of Whales (DIW) (the number of individual whales sighted by 100 n.miles) was calculated by each Lat.1° × Long.1° grid squares.

RESULTS AND DISCUSSIONS

Searching efforts

A total of 353,134 n.miles was surveyed in Areas III E, IV, V and VIW, south of 60°S between 1989/90 and 2008/09. Figure 2 shows the distribution of the primary searching effort.

Distribution pattern of whales

Tables 1a and 1b show a summary of primary sightings of baleen and toothed whales, respectively. Table 2 shows the number of calves, observed mean school size and DIW, by species and month. Figures 3a–d show the maps of the DIW for i) blue, fin and sei whales; ii) Antarctic minke, dwarf minke and humpback whales; iii) southern right, sperm and southern bottlenose whales; and iv) unidentified beaked (*Ziphiidae*) and killer whales, respectively, by each Lat.1° × Long.1° grid squares. Figure 4 shows the monthly change in DIW for most of the species.

A description of the geographical distribution by whale species is presented and discussed below.

Blue whale

Blue whale had the 8th rank of DIW among the ten species sighted in the research area (Table 2). They were

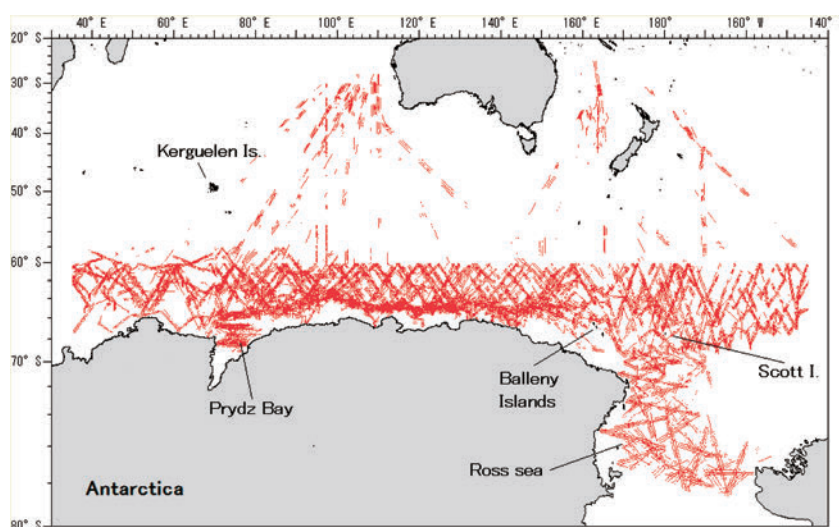

Figure 2. Searching efforts (red line) by JARPA and JARPAIL surveys in the period 1987/88–2008/09, including transit sighting survey in middle latitude.

Table 1a
Summary of baleen whale species sighted in the Indo-Pacific region of the Antarctic.

No.	Season	Effort (n.miles)	Blue whale			Fin whale			Sei whale			Ant. minke whale			Humpback whale			S. right whale		
			sch.	ind.	calf	sch.	ind.	calf	sch.	ind.	calf	sch.	ind.	calf	sch.	ind.	calf	sch.	ind.	calf
1	1987/88	8,860.6	0	0	0	3	3	0	1	1	0	237	719	0	35	76	0	1	1	0
2	1988/89	10,806.7	2	3	0	7	16	0	0	0	0	353	768	0	1	2	0	0	0	0
3	1989/90	16,423.2	5	9	0	5	20	0	0	0	0	758	1,968	0	121	210	11	2	2	0
4	1990/91	14,660.0	4	6	0	33	67	0	0	0	0	740	1,713	0	58	90	0	0	0	0
5	1991/92	17,844.1	3	3	0	8	34	0	2	2	0	597	2,030	1	177	321	7	26	30	0
6	1992/93	13,924.9	7	9	0	15	27	1	2	4	0	1,024	3,228	0	28	56	5	3	4	0
7	1993/94	17,957.3	5	9	0	9	26	0	0	0	0	688	1,619	0	133	220	1	11	14	0
8	1994/95	14,047.7	13	20	1	73	241	1	2	5	0	823	2,453	0	131	228	9	0	0	0
9	1995/96	21,466.7	9	16	0	60	214	1	0	0	0	887	2,008	0	325	562	10	8	8	0
10	1996/97	17,783.2	7	9	0	37	82	1	1	1	0	853	2,610	0	114	200	3	0	0	0
11	1997/98	21,594.4	16	25	0	18	57	0	0	0	0	672	1,373	0	577	1,122	2	34	37	0
12	1998/99	8,066.5	4	7	1	45	222	1	0	0	0	826	2,665	0	106	203	7	0	0	0
13	1999/2000	16,341.5	25	53	2	66	356	3	0	0	0	1,507	6,581	0	661	1,269	5	3	3	0
14	2000/01	20,421.3	10	18	0	114	374	0	7	13	0	1,907	4,949	0	191	341	3	2	2	0
15	2001/02	19,767.4	17	26	1	143	983	2	1	2	0	1,867	4,374	0	1219	2,387	5	15	22	1
16	2002/03	18,126.2	5	10	0	52	216	0	8	14	0	2,420	6,531	0	145	228	4	0	0	0
17	2003/04	19,287.4	32	61	0	109	446	0	0	0	0	1,092	3,250	0	1690	3,134	5	1	2	1
18	2004/05	18,486.7	12	16	0	49	118	1	1	1	0	1,663	4,278	0	197	336	2	2	2	0
19	2005/06	16,372.7	24	38	2	188	748	1	2	3	0	1,657	4,375	0	1702	3,200	22	53	73	4
20	2006/07	11,968.8	7	12	1	37	253	0	0	0	0	969	2,169	0	160	283	13	0	0	0
21	2007/08	14,575.3	43	84	1	48	134	4	2	2	0	823	1,702	0	1314	2,536	7	72	96	0
22	2008/09	14,351.4	14	28	1	109	440	2	5	7	0	1,870	4,668	0	339	587	8	0	0	0
Total		353,134	264	462	10	1,228	5,077	18	34	55	0	24,233	66,031	1	9,424	17,591	129	233	296	6

Table 1b
Summary of toothed whale species sighted in the Indo-Pacific region of the Antarctic.

No.	Season	Effort (n.miles)	Sperm whale			S. bottlenose whale			Unid. beaked whales			Killer whale		
			sch.	ind.	calf	sch.	ind.	calf	sch.	ind.	calf	sch.	ind.	calf
1	1987/88	8,860.6	6	6	0	3	5	0	87	218	0	20	194	0
2	1988/89	10,806.7	81	91	0	2	4	0	65	143	0	31	189	0
3	1989/90	16,423.2	204	215	0	23	46	0	281	514	0	69	859	0
4	1990/91	14,660.0	175	188	0	13	26	0	241	421	1	32	870	2
5	1991/92	17,844.1	225	233	0	29	51	0	181	304	1	53	805	0
6	1992/93	13,924.9	105	108	0	10	19	0	202	361	0	82	1,130	0
7	1993/94	17,957.3	321	336	0	145	243	0	205	337	0	56	399	1
8	1994/95	14,047.7	133	135	0	74	146	1	168	263	0	35	281	1
9	1995/96	21,466.7	341	352	0	137	273	1	161	284	0	109	1,282	1
10	1996/97	17,783.2	121	128	0	75	128	0	78	144	1	50	539	4
11	1997/98	21,594.4	295	302	0	222	409	0	197	338	0	82	931	9
12	1998/99	8,066.5	49	50	0	23	53	0	35	54	0	35	409	5
13	1999/2000	16,341.5	195	204	0	138	251	0	110	188	0	109	2,011	7
14	2000/01	20,421.3	100	106	0	72	121	0	173	272	0	72	1,471	2
15	2001/02	19,767.4	269	272	0	126	226	0	134	205	0	79	939	0
16	2002/03	18,126.2	128	129	0	97	168	0	113	154	0	63	953	0
17	2003/04	19,287.4	222	223	0	154	274	0	208	338	0	120	1,348	0
18	2004/05	18,486.7	105	108	0	44	78	0	89	159	0	78	1,472	3
19	2005/06	16,372.7	181	182	0	88	179	0	135	244	0	100	1,563	3
20	2006/07	11,968.8	63	63	0	51	80	0	66	88	0	44	394	0
21	2007/08	14,575.3	280	280	0	79	157	1	102	155	0	62	790	0
22	2008/09	14,351.4	75	76	0	32	61	0	77	140	0	38	788	14
Total		353,134.0	3,674	3,787	0	1,637	2,998	3	3,108	5,324	3	1,419	19,617	52

widely distributed in the research area in both northern and southern strata. High density values of this species were observed in Areas III E, particularly between 45°E and 65°E (Figure 3a). They were rarely found in the Prydz Bay. Blue whales were sighted within the Ross Sea between 70°S and 77°S. A total of 286 schools (495 individuals) including eleven calves were sighted south of 60°S (Table 2). Observed mean school size was 1.73 individuals. The DIW of this species was 0.140 for the whole period and the indices were almost stable from December to March (Table 2 and Figure 4).

Two subspecies of blue whales exist in Southern Hemisphere: the Antarctic (or true) blue whale (*Balaenoptera musculus intermedia*) and the pygmy blue whale (*B. m. breviceauda*) (Mackintosh, 1966; Ichihara, 1966; Rice, 1998). A complete review of spatial and seasonal distribution, densities and movements of blue whales is provided by Branch (2007) and Branch *et al.* (2007). These studies indicated that there is little evidence that pygmy blue whales migrate into high latitudes of the Antarctic. Less than 1% of the records south of 52°S were of this subspecies. There is no current evidence of population structure in Antarctic blue whales. The latest abundance estimate of this species (south of 60°S, 35°E–145°W) was 1,223 whales (CV=0.345) in 2007/08+2008/09 seasons, and the abundance trend was 8.2% (95% CI: 3.9%, 12.5%) between 1995/96 and 2008/09 for combined Areas III E+IV+V+VIW based on JARPAIL data (Matsuoka and Hakamada, 2014). There is a need for continued monitoring of the abundance and abundance trend of this species, especially because they provide an excellent opportunity

to improve our understanding of the dynamics of baleen whale populations recovering from low levels.

Fin whale

Fin whale had the 5th rank of DIW among the ten species sighted in the research area. A total of 1,268 schools (5,209 individuals) including 20 calves, were sighted (Table 2). Observed mean school size was 4.11 individuals. This species was more frequently encountered in Areas V and VIW than in Areas III E and IV in both northern and southern strata. High density areas were observed in Areas III E, particularly between 55°E and 65°E, VW, between 140°E and 160°E and VE between 163°E and 170°W (Figure 3a). The DIW of this species was 1.475 for the whole period and the indices increased from December to March (Figure 4).

In the Antarctic feeding grounds, fin whales occur year-round but higher density is found from November to May (Kasamatsu *et al.*, 1996; Mackintosh, 1966). Whales can be found as far south as 65°S–70°S, but the majority of the population seems to occur north of 60°S (Miyashita *et al.*, 1995). Catches occurred throughout the Antarctic, but the majority of whales (~73%) were taken in the IWC Management Areas II and III. Sighting data suggest that spatial distribution varies across ocean basins (Kasamatsu *et al.*, 1996).

Sei whale

Sei whale was rarely sighted in the research area. A total of 36 schools (59 individuals) were sighted south of 60°S (Table 2) and no calves were observed. Observed mean

Table 2

Summary of sighting information in the whole research area in the period 1987/88–2008/09, by whale species and month. Sch.: number of primary sightings of schools; Ind.: number of primary sightings of individuals; Calf: number of calves; Mss: mean school size (Ind./Sch.); DIS: Density Index (schools/100 n.miles); DIW: Density Index (individuals/100 n.miles).

Species	All Areas (III E, IV, V and VIW; south of 60°S, 35°E–145°W)						Order of DIW	Dec. DIW	Jan. DIW	Feb. DIW	Mar. DIW
	Sch.	Ind.	Calf	Mss	DIS	DIW					
	Blue whale	286	495	11	1.73	0.081					
Fin whale	1,268	5,209	20	4.11	0.359	1.475	5	1.323	0.794	1.760	3.059
Sei whale	36	59	0	1.64	0.010	0.017	10	0.002	0.004	0.020	0.044
Antarctic minke whale	25,507	69,076	0	2.71	7.223	19.561	1	10.173	14.301	33.331	19.436
Humpback whale	10,036	18,770	137	1.87	2.842	5.315	3	3.425	4.842	7.337	6.708
Southern right whale	235	298	6	1.27	0.067	0.084	9	0.001	0.014	0.156	0.292
Sperm whale	3,810	3,926	0	1.03	1.079	1.112	6	1.500	1.272	0.992	0.292
S. bottlenose whale	1,666	3,045	3	1.83	0.472	0.862	7	0.932	0.974	0.787	0.570
Unid. beaked whale	3,175	5,457	3	1.72	0.899	1.545	4	1.864	1.594	1.123	1.209
Killer whale	1,472	20,569	59	13.97	0.417	5.825	2	1.935	5.692	9.303	6.624

school size was 1.64 individuals. This species occurred more frequently in Areas V and VIW than in Areas III E and IV in the northern strata (Figure 3a). The DIW of this species was 0.017 for the whole period.

In summer, sei whales do not venture into higher

latitude waters near the Antarctic continent as much as some other baleen whales (Horwood, 1987; Miyashita *et al.*, 1995). The majority of the population occurs between 40°S and 60°S, usually north of the Antarctic Convergence. Juveniles are found further north than

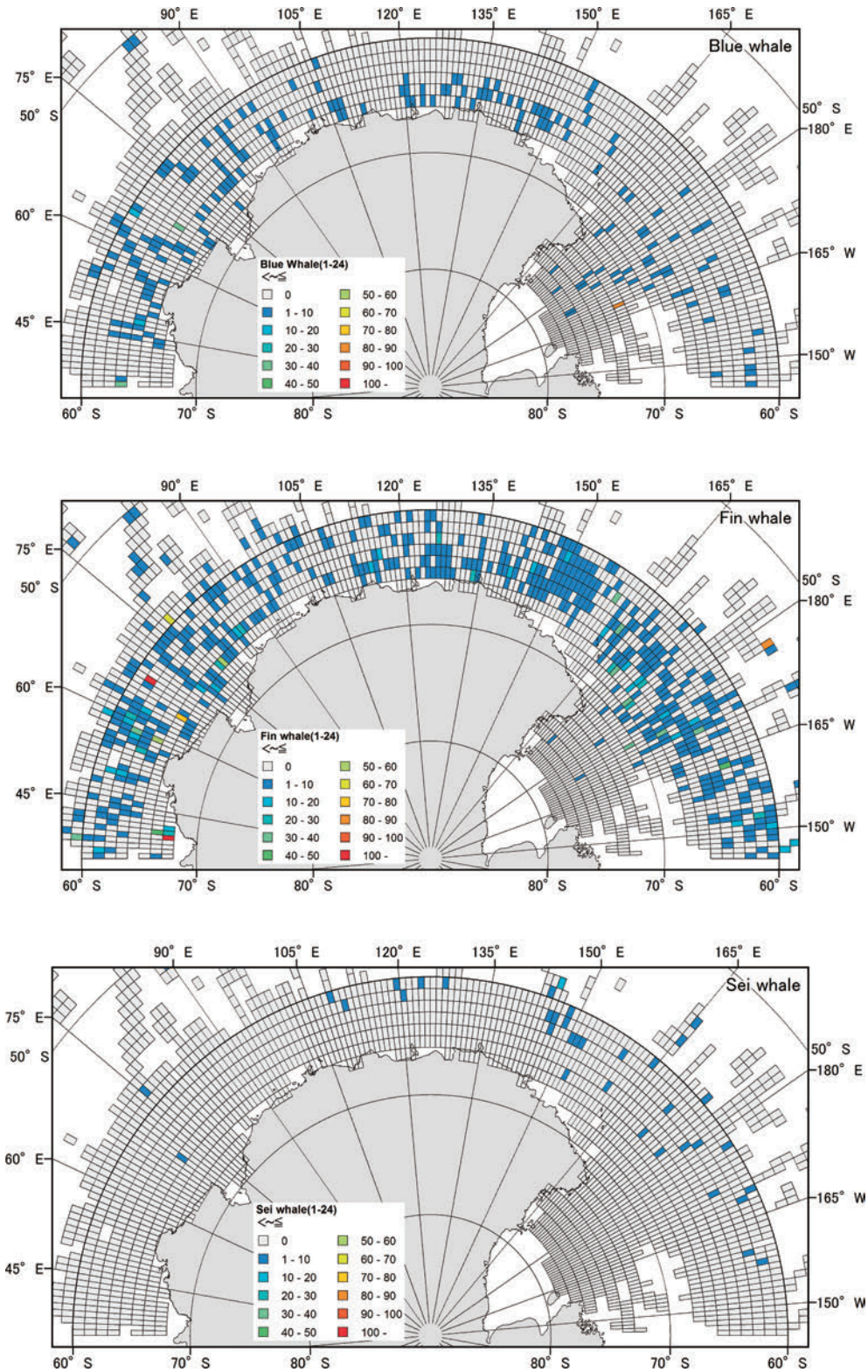

Figure 3a. DIW of blue (top), fin (middle) and sei (bottom) whales in the Indo-Pacific region of the Antarctic, by Lat.1°× Long.1°square (whole research period).

mature individuals. Occurrence in low latitude wintering grounds has been recorded from March to December, but abundance peaks from June/July to August/September (Horwood, 1987). In late spring and summer, abundance peaks in November between 30°S and 50°S. As the season progresses relatively more whales are observed

south of 40°S and abundance between 50°S and 60°S increases consistently until March (Horwood, 1987). The results in the present study are consistent with those of previous studies.

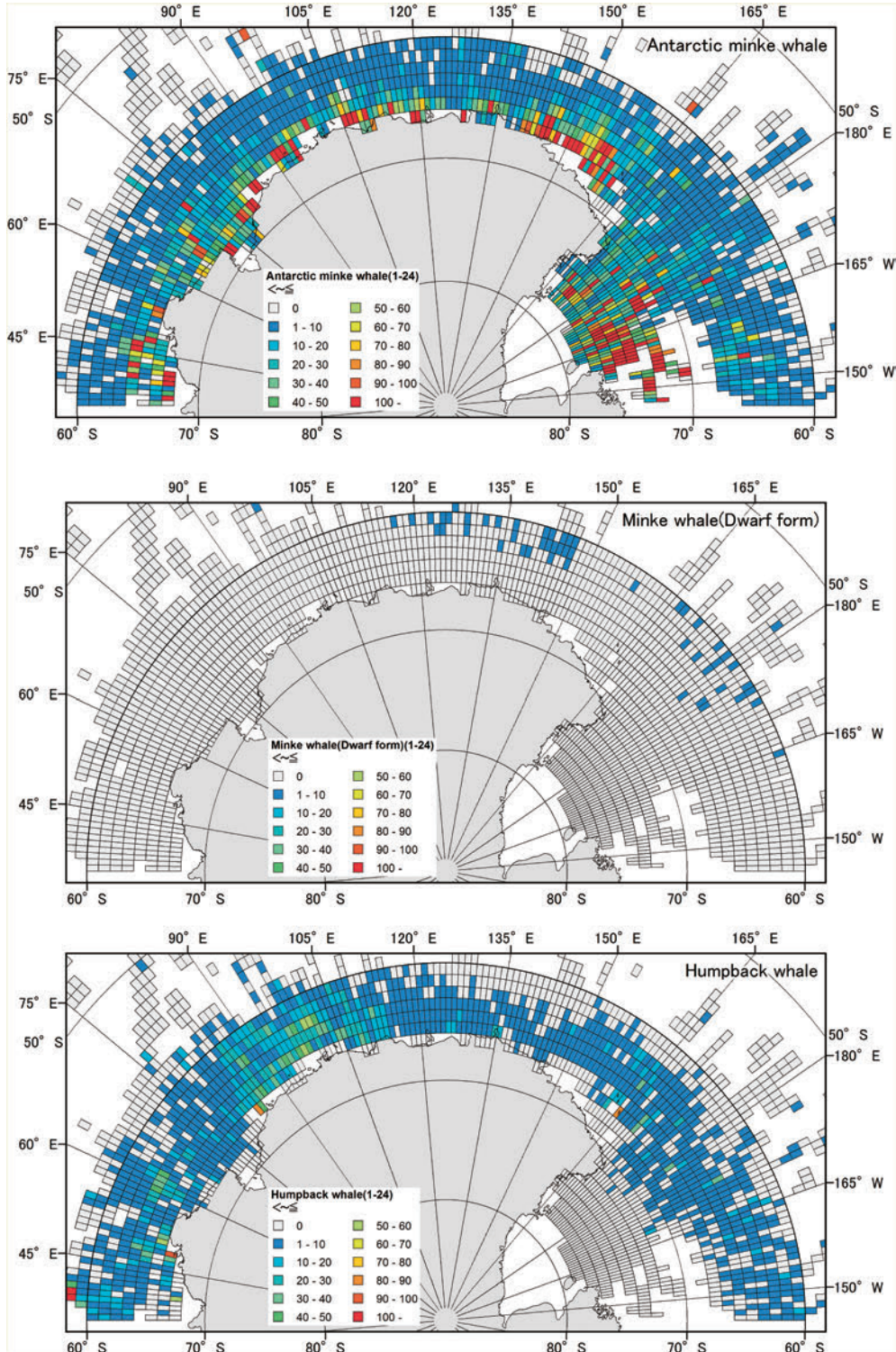

Figure 3b. DIW of Antarctic minke (top), dwarf minke (middle) and humpback (bottom) whales in the Indo-Pacific region of the Antarctic, by Lat.1°× Long.1°square (whole research period).

Antarctic minke whale

This was the most frequently sighted species throughout the surveys. A total of 25,507 schools (69,076 individuals) were sighted south of 60°S (Table 2). No calves were observed. Observed mean school size was 2.71 individuals. High density areas were observed along the ice-edge, especially the Ross Sea and Prydz Bay (Figure 3b). The DIW of this species for the whole period was the highest (19.561). The indices increased from December to February and decreased in March (Figure 4).

In the austral summer the majority of Antarctic minke whales congregate in the Southern Ocean, with greatest densities close to and within the pack ice, and lower densities with increasing distance from the ice (Kasamatsu *et al.*, 2000; Hakamada and Matsuoka, 2014a), including some north of 60°S. Antarctic minke whales are noticeably well adapted to living within the ice (Ainley *et al.*, 2007), but the exact proportion of Antarctic minke whales found within the pack ice, and in polynyas, is currently a source of debate. It is possible that a large proportion of the population is found within the pack ice, out of reach of vessel-based sighting surveys (Murase *et al.*, 2005; 2014; Shimada and Kato, 2007).

Dwarf minke whale

Distribution of this species was limited within the research area. There are two separated areas of distribution, between 120°E and 147°E, and between 165°E and 170°W in the northern stratum (mainly between 60°S and 63°S), south of Australia and New Zealand (Figure 3b). The dwarf minke whale has a white band on the flipper that distinguishes it from the Antarctic minke whale, but was only fairly recently identified as separate from Antarctic minke whales (Best, 1985). On available information, only a small percentage of minke whales in the Antarctic (south of 60°S) are dwarf minke whales. For example, in the IDCR/SOWER surveys from 1993/94–1997/98 only 0.2% of the identified sightings were dwarf minke whales (2 out of 906). No formal analysis has been conducted but it is probable that less than 1% of the minke whales south of 60°S are dwarf minke whales (Branch and Butterworth, 2001).

Humpback whale

Humpback whale had the 3rd rank among the ten species sighted in the research area. A total of 10,036 schools (18,770 individuals) including 137 calves were sighted (Table 2). Observed mean school size was 1.87 individuals. They were widely distributed in the research area in both northern and southern strata. They were rarely

found within the Prydz Bay and the Ross Sea and no sighting occurred south of 73°S. High density values of this species were observed between 85°E and 110°E (Figure 3b). The DIW of this species was 5.315 for the whole period. Indices increased from December to February and decreased in March (Figure 4).

IDCR/SOWER circumpolar surveys encountered humpback whales more frequently in the sectors 20–40°E, 80°E–100°E and 150°E–180°E (Branch, 2011). The current distribution map of this species suggests that humpback whales are encountered more frequently in the sector 80°E–100°E because of its high productivity. In the sector 80°E and 100°E, large scale distribution changes were observed (Matsuoka *et al.*, 2011; Murase *et al.*, 2014; Hakamada and Matsuoka, 2014b). It has been suggested that such changes are related to changing oceanographic conditions such as the effect of the regime shift in the global sea-surface temperatures in relation to El Niño-southern oscillation events (Watanabe *et al.*, 2014; Naganobu *et al.*, 2014). This should be further investigated in the future.

Southern right whale

A total of 235 schools (298 individuals) involving six calves were sighted (Table 2). Distribution area of this species was limited to the sector 80°E and 135°E, south of Western Australia (Figure 3c). The DIW of this species was 0.084 for the whole period. Indices increased from December to March (Figure 4). In summer southern right whales migrate south but generally not as far south as other baleen whale species. They appear to occur near the subtropical convergence in summer (January to March) at around 40°S–50°S (Ohsumi and Kasamatsu, 1985), but there are records of animals much further south (e.g. around 60°S–65°S south of Australia (Bannister *et al.*, 1999; 2008). The present distribution map of this species is consistent with these previous studies. The population estimate for the coastal area of Western Australia was 2,400 in 2006 (Bannister, 2008). A current estimate in Area IV south of 60°S is 1,557 individuals (95% CI: 871–2,783) in the 2007/08 season based on JARPAII data (Matsuoka and Hakamada, 2014).

Sperm whale

Sperm whale had the 6th rank among the ten species sighted in the research area. A total of 3,810 schools (3,926 individuals) were sighted. No calves were observed (Table 2). Single large males were mainly sighted (96.5%) and consequently the observed mean school size was 1.03. They were widely distributed in the research

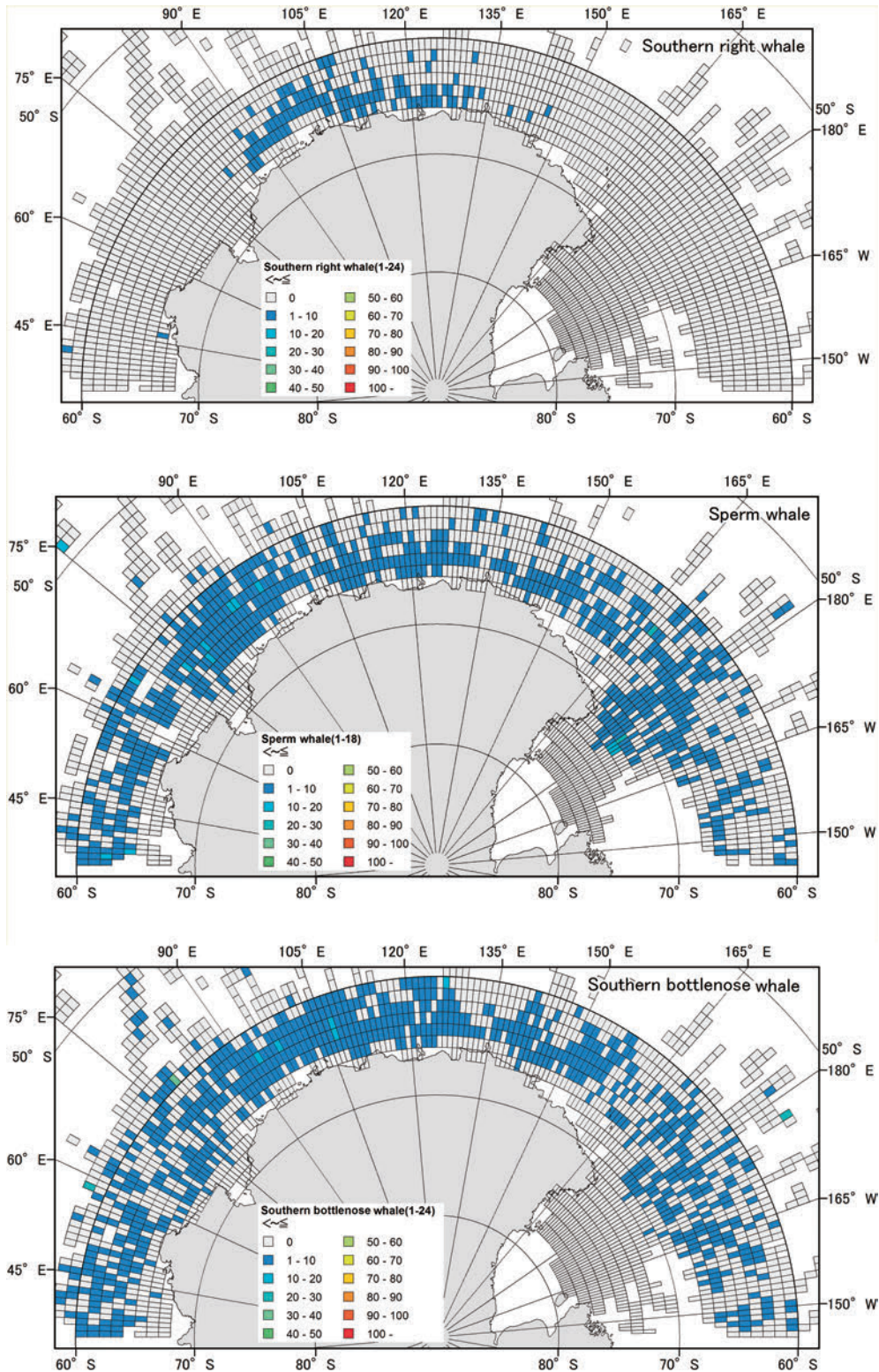

Figure 3c. DIW of southern right (top), sperm (middle) and southern bottlenose (bottom) whales in the Indo-Pacific region of the Antarctic, by Lat.1°× Long.1°square (whole research period).

area. High density values of sperm whales were observed in Area IV (between 70°E and 100°E) and Area V (between 170°E and 170°W, in the mouth of the Ross Sea (Figure 3c). They tended to be concentrated on the Antarctic continental slope, on the southern Kerguelen Plateau,

and around the mouth of the Ross Sea, where most frequently the depth was between 1,000 m and 4,000 m. They were rarely found within the Prydz Bay and the Ross Sea (Figure 3c). There were no sightings south of 74°S in the Ross Sea. The DIW of this species was 1.081 for the

whole period. The indices decreased from December to March (Figure 4).

Southern bottlenose whale

Southern bottlenose whale had the 7th rank among the ten species sighted in the research area. A total of 1,666 schools (3,045 individuals) including three calves were sighted (Table 2). They were widely distributed in the research area but were rarely sighted within the Prydz Bay and the Ross Sea. High density values of this whale were observed between 85°E and 130°E (Figure 3c). Observed mean school size was 1.83 individuals. The DIW of this species was 0.862 for the whole period. Indices decreased from December to March (Figure 4).

Unidentified beaked whales

Unidentified beaked whales had the 4th rank among the ten species sighted in the research area. A total of 3,175 schools (5,457 individuals) including three calves were

sighted (Table 2). The sightings were recorded as unidentified species of beaked whales. This 'unidentified beaked whales' possibly included southern bottlenose whale (*Hyperoodon planifrons*), Arnoux's beaked whale (*Berardius arnuxii*), strap-toothed whale (*Mesoplodon layardii*) and Grey's beaked whale (*M. grayi*). Distribution pattern of the unidentified beaked whales was consistent with that of southern bottlenose whales (Figure 3d).

Killer whale

Killer whale had the 2nd rank among the ten species sighted in the research area. A total of 1,472 schools (20,569 individuals) including 59 calves were sighted (Table 2). Observed mean school size was 13.97 individuals. The DIW of this species was 5.825 for the whole period (Table 2). They were widely distributed in the research area and were more frequently sighted in the southern stratum. High density areas were observed within the Prydz Bay and the Ross Sea (Figure 3d).

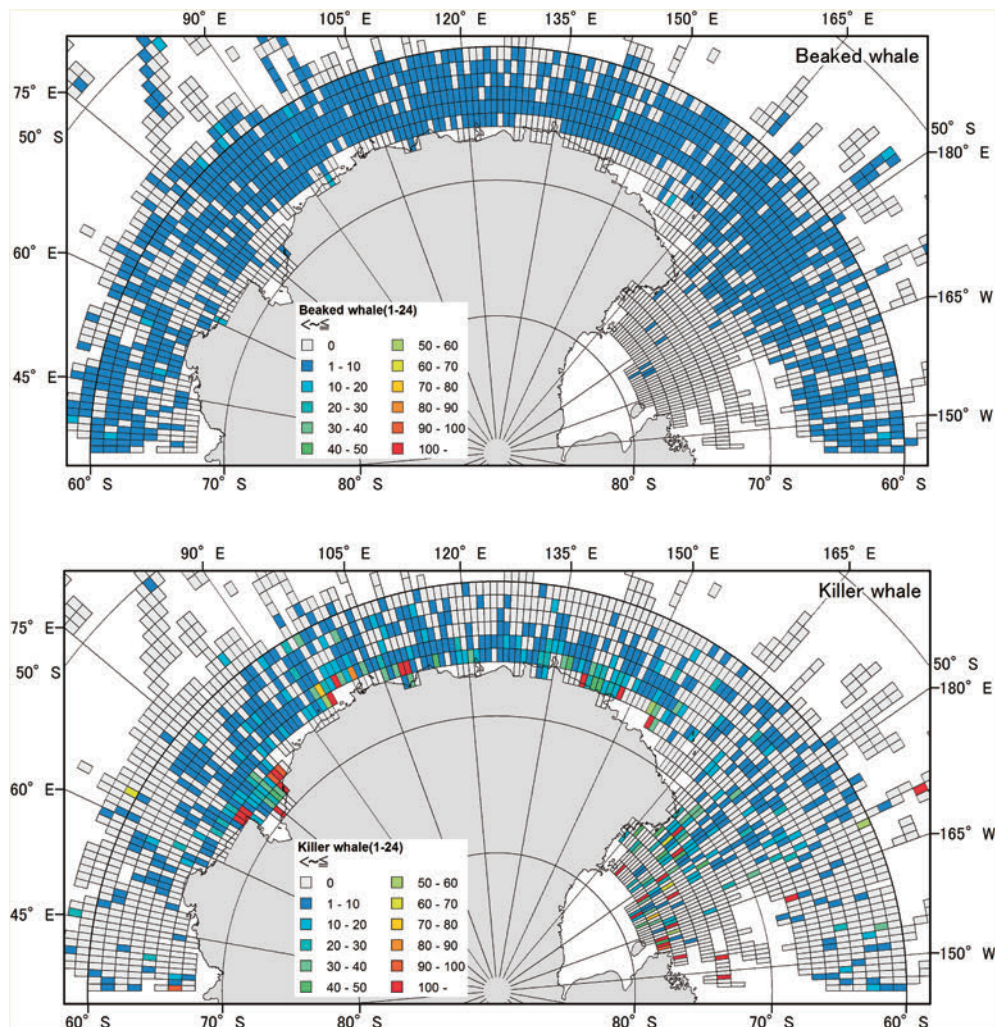

Figure 3d. DIW of unidentified beaked (top) and killer (bottom) whales in the Indo-Pacific region of the Antarctic, by Lat.1°× Long.1°square (whole research period).

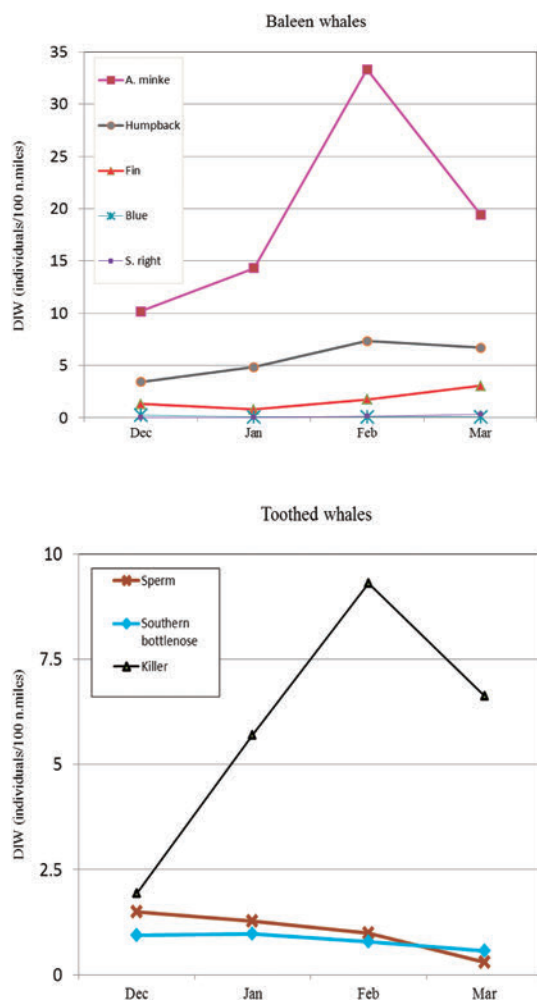

Figure 4. Monthly change of DIW for baleen (top) and toothed (bottom) whales in the whole research area and period.

Relationship between pattern of distribution and oceanographic conditions

There is a common pattern for several whale species to concentrate mainly in the sector 80°E and 110°E, south of 60°S. This area was characterized by a large meander (rise to 61°S and slow-moving down to 63°S) of the southern boundary of the Antarctic Circumpolar Current (ACC) which seemed to be caused by large scale up-welling with nutritious bottom waters resulting from the bottom shape of the southern Kerguelen Plateau (Watanabe *et al.*, 2006; 2014; Naganobu *et al.*, 2014). The BROKE, Australian Antarctic survey, indicated the possibility of the occurrence of large-scale upwelling between 80°E and 100°E (Bindoff *et al.*, 2000). In the 1999/2000 JARPA survey, a high density of *Euphausiids* was reported between 100°E and 120°E (Murase *et al.*, 2002). Humpback, southern right, large male sperm and southern bottlenose whales used this longitudinal sector between 80°E and 100°E as their key feeding area during December

to March. It is necessary to further investigate the relationship between whale distribution and oceanographic condition shifts such as the effect of the regime shift in the global sea-surface temperatures in relation to El Nino-southern oscillation events (Matsuoka *et al.*, 2003; Watanabe *et al.* 2014; Naganobu *et al.*, 2006; 2014).

ACKNOWLEDGEMENTS

We thank all researchers, captains, officers and crew members that participated in the JARPA and JARPAII surveys from which the data used in the present study were collected. We also thank S. Suzuki for help in drawing some of the figures.

REFERENCES

- Ainley, D.G., Dugger, K.M., Toniolo, V. and Gaffney, I. 2007. Cetacean occurrence patterns in the Amundsen and southern Bellingshausen Sea sector, Southern Ocean. *Marine Mammal Science* 23 (2): 287–305.
- Bannister, J.L., Pastene, L.A. and Burnell, S.R. 1999. First record of movement of a southern right whale (*Eubalaena australis*) between warm water breeding grounds and the Antarctic Ocean, south of 60°S. *Marine Mammal Science* 15 (4): 1337–1342.
- Bannister, J.L. 2008. Population trend in right whales off southeastern Australia 1993–2007. Paper SC/60/BRG14 presented to the IWC Scientific Committee, June 2008 (unpublished). 13 pp. [Available from the IWC Secretariat].
- Best, P.B. 1985. External characters of southern minke whales and the existence of a diminutive form. *Sci. Rep. Whales Res. Inst.* 36: 1–33.
- Bindoff, N.L., Rosenburg, M.A. and Warner, M.J. 2000. On the circulation and water masses over the Antarctic continental slope and rise between 80°E and 150°E. *Deep-Sea Research II: Tropical Studies in Oceanography* 47: 2299–2326.
- Branch, T.A. and Butterworth, D.S. 2001. Estimates of abundance south of 60°S for cetacean species sighted frequently on the 1978/79 to 1997/98 IWC/IDCR-SOWER sighting surveys. *J. Cetacean Res. Manage.* 3 (3): 251–270.
- Branch, T.A., Matsuoka, K. and Miyashita, T. 2004. Evidence for increases in Antarctic blue whales based on Bayesian modelling. *Marine Mammal Science* 20 (4): 726–754.
- Branch, T.A. 2007. Abundance of Antarctic blue whales south of 60°S from three complete circumpolar sets of surveys. *J. Cetacean Res. Manage.* 9 (3): 87–96.
- Branch, T.A., Stafford, K.M., Palacios, D.M., Allison, C., Bannister, J.L., Burton, C.L.K., Cabrera, E., Carlson, C.A., Galletti Vernazzani, B., Gill, P.C., Huckle-Gaete, R., Jenner, K.C.S., Jenner, M.-N.M., Matsuoka, K., Mikhalev, Y.A., Miyashita, T., Morrice, M.G., Nishiwaki, S., Sturrock, V.J., Tormosov, D., Anderson, R.C., Baker, A.N., Best, P.B., Borsa, P., Brownell Jr, R.L., Childerhouse, S., Findlay, K.P., Gerrodette, T., Ilangakoon,

- A.D., Joergensen, M., Kahn, B., Ljungblad, D.K., Maughan, B., Mccauley, R.D., Mckay, S., Norris, T.F., Oman Whale and Dolphin Research Group, Rankin, S., Samaran, F., Thiele, D., Van Waerebeek, K. and Warneke, R.M. 2007. Past and present distribution, densities and movements of blue whales *Balaenoptera musculus* in the Southern Hemisphere and northern Indian Ocean. *Mammal Rev.* 37 (2): 116–175.
- Branch, T.A. 2011. Humpback abundance south of 60°S from three completed sets of IDCR/SOWER circumpolar surveys. *J. Cetacean Res. Manage.* (Special Issue) 3: 53–69.
- Hakamada, T., Matsuoka, K. and Nishiwaki, S. 2006. An update of Antarctic minke whales abundance estimate based on JARPA data. Paper SC/D06/J6 presented to the JARPA Review Meeting, December 2006 (unpublished). 34 pp+Addendum 2 pp. [Available from the IWC Secretariat].
- Hakamada, T. and Matsuoka, K. 2014a. Estimates of abundance and abundance trend of the Antarctic minke whale in Areas III-E–VIW, south of 60°S, based on JARPA and JARPAII sighting data (1989/90–2008/09). Paper SC/F14/J3 presented to the IWC/SC Review Workshop of the Japanese Whale Research Program under Special Permit in the Antarctic-Phase II (JARPAII), February 2014 (unpublished). 41 pp. [Available from the IWC Secretariat].
- Hakamada, T. and Matsuoka, K. 2014b. Estimates of abundance and abundance trend of the humpback whale in Areas III-E–VIW, south of 60°S, based on JARPA and JARPAII sighting data (1989/90–2008/09). Paper SC/F14/J4 presented to the IWC/SC Review Workshop of the Japanese Whale Research Program under Special Permit in the Antarctic-Phase II (JARPAII), February 2014 (unpublished). 36 pp. [Available from the IWC Secretariat].
- Horwood, J. 1987. *The Sei Whale: Population Biology, Ecology and Management*. Croom Helm, London. 375 pp.
- Ichihara, T. 1966. The pygmy blue whale, *Balaenoptera musculus brevicauda*, a new subspecies from the Antarctic. pp. 79–113. In: K.S. Norris (ed.) *Whales, dolphins, and porpoises*. University of California Press, Berkeley, CA. 789 pp.
- Kasamatsu, F., Joyce, G., Ensor, P. and Mermoz, J. 1996. Current occurrence of baleen whales in Antarctic waters. *Rep. Int. Whal. Commn* 46: 293–304.
- Kasamatsu, F., Matsuoka, K. and Hakamada, T. 2000. Interspecific relationships in density among the whale community in the Antarctic. *Polar Biol.* 23: 466–473.
- Kishino, H., Kato, H., Kasamatsu, F. and Fujise, Y. 1991. Detection heterogeneity and estimation of population characteristics from the field survey data: 1987/88 Japanese feasibility study of the Southern Hemisphere minke whales. *Ann. Inst. Statist. Math.* 43: 435–453.
- Mackintosh, N.A. 1966. Distribution of southern blue and fin whales. pp. 125–144. In: K.S. Norris (ed.) *Whales, dolphins, and porpoises*. University of California Press, Berkeley, CA. 789 pp.
- Matsuoka, K., Watanabe, T., Ichi, T., Shimada, H. and Nishiwaki, S. 2003. Large whale distributions (south of 60°S, 35°E–130°E) in relation to the southern boundary of the ACC. pp. 26–30. In: A.H.L. Huiske, W.W.C. Gieskes, J. Rozema, R.M.L. Schrnö, S.M. van der Vies and W.J. Wolff (eds.) *Antarctic Biology in a Global Context*. Backhuys Publishers, Leiden, The Netherlands. 338 pp.
- Matsuoka, K., Hakamada, T., Kiwada, H., Murase H. and Nishiwaki, S. 2011. Abundance estimates and trends for humpback whales (*Megaptera novaeanglie*) in the Antarctic Areas IV and V based on JARPA sighting data. *J. Cetacean Res. Manage.* (Special Issue) 3: 75–94.
- Matsuoka, K. and Hakamada, T. 2014. Estimates of abundance and abundance trend of the blue, fin and southern right whales in Areas III-E–VIW, south of 60°S, based on JARPA and JARPAII sighting data (1989/90–2008/09). Paper SC/F14/J5 presented to the IWC/SC Review Workshop of the Japanese Whale Research Program under Special Permit in the Antarctic-Phase II (JARPAII), February 2014 (unpublished). 27 pp. [Available from the IWC Secretariat].
- Miyashita, T., Kato, H. and Kasuya, T. (eds.) 1995. *Worldwide Map of Cetacean Distribution based on Japanese Sighting Data (Volume 1)*. National Research Institute of Far Seas Fisheries, Shimizu, Japan. 140 pp.
- Murase, H., Matsuoka, K., Ichii, T. and Nishiwaki, S. 2002. Relationship between the distribution of *euphausiids* and baleen whales in the Antarctic (35°E–145°W). *Polar Biol.* 25: 135–145.
- Murase, H., Shimada, H. and Kitakado, T. 2005. Alternative estimation of Antarctic minke whale abundance taking account of possible animals in the unsurveyed large polynya using GAM-based spatial analysis: A case study in Area II in 1997/98 IWC/SOWER. Paper SC/57/IA6 presented to the IWC Scientific Committee, May–June 2005 (unpublished). 20 pp. [Available from the IWC Secretariat].
- Murase, H., Matsuoka, K., Hakamada, T. and Kitakado, T. 2014. Preliminary analysis of changes in spatial distribution of Antarctic minke and humpback whales in Area IV during the period of JARPA and JARPAII from 1989 to 2006. Paper SC/F14/J18 presented to the IWC/SC Review Workshop of the Japanese Whale Research Program under Special Permit in the Antarctic-Phase II (JARPAII), February 2014 (unpublished). 17 pp. [Available from the IWC Secretariat].
- Naganobu, M., Nishiwaki, S., Yasuma, H., Matsukura, R., Takao, Y., Taki, K., Hayashi, T., Watanabe, Y., Yabuki, T., Yoda, Y., Noiri, Y., Kuga, M., Yoshikawa, K., Kokubun, N., Murase, H., Matsuoka, K. and Ito, K. 2006. Interactions between oceanography, krill and baleen whales in the Ross Sea and Adjacent Waters: An overview of *Kaiyo Maru*-JARPA joint survey in 2004/05. Paper SC/D06/J23 presented to the JARPA Review Meeting, December 2006 (unpublished). 33 pp. [Available from the IWC Secretariat].
- Naganobu, M., Matsuoka, K. and Kutsuwada, K. 2014. Consideration on the Kerguelen-Davis Oscillation Index

- (KDOI) influencing variability on environmental ecosystem in the Prydz Bay Region, east Antarctic: data exploration. Paper SC/F14/J21 presented to the IWC/SC Review Workshop of the Japanese Whale Research Program under Special Permit in the Antarctic-Phase II (JARPAII), February 2014 (unpublished). 12 pp. [Available from the IWC Secretariat].
- Nishiwaki, S., Ishikawa, H., Goto, M., Matsuoka, K. and Tamura, T. 2014. Review of general methodology and survey procedure under the JARPAII. Paper SC/F14/J2 presented to the IWC/SC Review Workshop of the Japanese Whale Research Program under Special Permit in the Antarctic-Phase II (JARPAII), February 2014 (unpublished). 34 pp. [Available from the IWC Secretariat].
- Ohsumi, S. and Kasamatsu, F. 1985. Recent off-shore distribution of the southern right whale in summer. *Rep. Int. Whal. Commn* (Special Issue) 10: 177–185.
- Rice, D.W. (ed.) 1998. *Marine mammals of the world: systematics and distribution*. Society for Marine Mammalogy, Lawrence, KS. 231 pp.
- Shimada, H. and Kato, A. 2007. Population assessment of the Antarctic minke whale within and out ice field using a sighting data by the Ice Breaker and the IWC SOWER vessels in 2004/2005. Paper SC/59/IA16 presented to the IWC Scientific Committee, May 2007 (unpublished). 8 pp. [Available from the IWC Secretariat].
- Watanabe, T., Yabuki, T., Suga, T., Hanawa, K., Matsuoka, K. and Kiwada, H. 2006. Results of oceanographic analyses conducted under JARPA and possible evidence of environmental changes. Paper SC/D06/J30 presented to the JARPA Review Meeting, December 2006 (unpublished). 13 pp. [Available from the IWC Secretariat].
- Watanabe, T., Okazaki, M. and Matsuoka, K. 2014. Results of oceanographic analyses conducted under JARPA and JARPAII and possible evidence of environmental changes. Paper SC/F14/J20 presented to the IWC/SC Review Workshop of the Japanese Whale Research Program under Special Permit in the Antarctic-Phase II (JARPAII), February 2014 (unpublished). 10 pp. [Available from the IWC Secretariat].

Technical Report (not peer reviewed)

Earplug-based age determination and estimation of biological parameters in North Pacific Bryde's whales based on samples collected by JARPNII

Takeharu BANDO*

Institute of Cetacean Research, Toyomi-cho 4–5, Chuo-ku, Tokyo 104–0055, Japan

*Contact e-mail: bando@cetacean.jp

ABSTRACT

This study summarizes the results of earplug-based age determination and estimation of biological parameters in the western North Pacific Bryde's whales sampled by the JARPNII surveys between 2000 and 2016. A total of 730 whales (314 males and 416 females) was sampled in the western North Pacific north of 35°N and between the Pacific coast of Japan and 170°E. Age information was obtained from earplugs of 476 (65.2%) whales. Earplug readability was higher for mature (76.4%) than immature (43.8%) whales and no difference between sexes was observed. The growth curves for males and females were $L_t = 12.63(1 - e^{-0.208(t+4.266)})$, and $L_t = 13.28(1 - e^{-0.172(t+4.834)})$, respectively. The age at sexual maturity for males and females were 10.24 and 8.56 years, respectively. The annual ovulation rate was estimated as 0.526/year. It is concluded that substantial biological information was obtained for the North Pacific Bryde's whales during the 17 years of JARPNII. In particular the readability of earplugs for age determination increased notably compared to that in the period of commercial whaling. The analyses of biological data will contribute to the management of this whale species in the North Pacific, for example by incorporating such data into the conditioning process of the RMP Implementation Simulation Trials.

INTRODUCTION

Bryde's whales are widely distributed throughout the world, especially in waters with temperature of 20°C or more (Kato and Perrin, 2017). Two types of Bryde's whales are distributed around Japan, one in the south-western part of Japan (coastal type) and the other in offshore waters in the Pacific side of Japan (offshore type) (Kishiro, 1996; Yoshida and Kato, 1999).

Some authors (*e.g.*, Wada *et al.*, 2003) recognize these Bryde's whale types as two separate species, the smaller coastal one *Balaenoptera edeni* Anderson, 1879 (Eden's whale) and the larger offshore one *B. brydei* Olsen, 1913 (Bryde's whale). Other authors (*e.g.*, Kershaw *et al.* 2013) assign these species a sub-specific status: *B. edeni edeni* and *B. edeni brydei*, respectively. This study focused on the larger, offshore type Bryde's whale (Figure 1).

JARPNII started in 2000 with three research objectives, i) feeding ecology and ecosystem studies, ii) monitoring of environmental pollutants in cetaceans and marine ecosystems and iii) elucidation of stock structure (GOJ, 2000; 2002). Bryde's whale (offshore type) was selected as one of the target species for sampling. The estima-



Figure 1. North Pacific Bryde's whale (offshore type). Note the three distinct ridges in the head, which are characteristic of this species.

tion of biological parameters of whales was not included among the main objectives of JARPNII, however biological samples for such estimates were collected systematically during the surveys. The JARPNII was completed in 2016, and a total of 730 Bryde's whales were sampled during the 17 years survey period.

Age data is one of the most important information for

stock assessment and management of large whales. Age estimation based on earplugs is considered the most reliable tool for age determination in whales (Lockyer, 1984; Maeda *et al.*, 2016). Earplug readability of North Pacific Bryde's whales was reported as 17.4% from commercial whaling samples collected in the pelagic whaling ground of the North Pacific from 1971 to 1974 (Ohsumi, 1977). During the JARPNII, earplugs were collected carefully from each whale sampled, and efforts were made to increase the readability.

This study summarized the results of age determination in North Pacific Bryde's whales based on earplugs and some biological parameters based on age data. The analyses were based on Bryde's whale samples collected by JARPNII in the period 2000–2016 in the western North Pacific.

MATERIALS AND METHODS

Whale sampling

A total of 730 (314 males and 416 females) Bryde's whales were sampled by JARPNII during 2000–2016. The geographical distribution of the sampled whales is shown in Figure 2. Whales were sampled between the Japanese coast and 170°E, and between 35°N and approximately 42°N. Two biological stocks of Bryde's whales (offshore type) have been suggested for the western North Pacific, one distributed between the Japanese coast and approximately 165°E and the other, east of 180°, with a transition area between 165°E and 180° (IWC, 2017). The analyses in this study are mainly focused on the former stock.

Table 1 shows the number of sampled whales by year and sexual maturity status.

Biological data

Body length was measured in a straight line from the tip of snout to the notch of flukes using stainless steel measuring tapes. Sexual maturity of females was preliminarily determined in the field by the presence or absence of corpora lutea/albicantia in ovaries from both sides and confirmed later by counting corpora number at the laboratory. If there was at least one corpora lutea or albicantia in the ovaries, the female was determined as sexually mature. Maturity of males was determined by testis weight. Testis weight (heavier side) of more than 560g was regarded as sexually mature (Bando unpublished data).

Earplug sampling and age determination procedure

Earplugs were collected from all sampled animals, following the method developed for baleen whales (Omura, 1963; Maeda *et al.*, 2016). The left and right earplugs

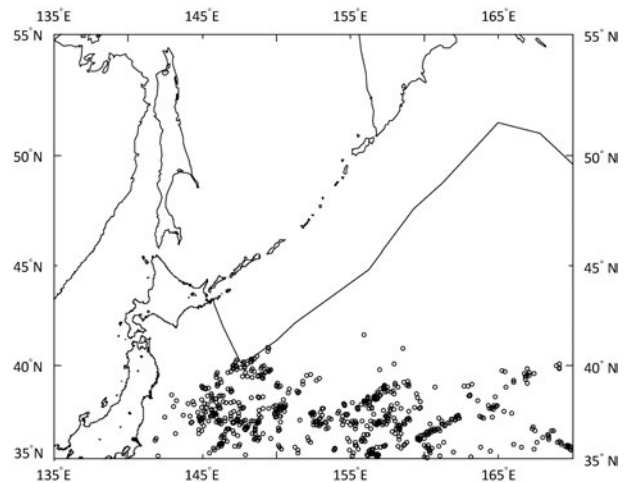

Figure 2. Research area of JARPNII and sighting positions of Bryde's whales sampled during the 2000–2016 surveys.

Table 1

Sex and sexual maturity status of Bryde's whales sampled during 2000 to 2016 JARPNII.

	Male			Female			Total
	Immature	Mature	Total	Immature	Mature	Total	
2000	9	12	21	6	16	22	43
2001	13	4	17	12	21	33	50
2002	18	7	25	11	14	25	50
2003	10	9	19	9	22	31	50
2004	5	14	19	7	24	31	50
2005	10	11	21	13	16	29	50
2006	8	13	21	8	21	29	50
2007	13	10	23	5	22	27	50
2008	6	24	30	4	16	20	50
2009	9	9	18	14	18	32	50
2010	5	20	25	4	21	25	50
2011	10	10	20	11	19	30	50
2012	6	5	11	4	19	23	34
2013	3	10	13	3	12	15	28
2014	2	4	6	5	14	19	25
2015	3	11	14	2	9	11	25
2016	1	10	11	2	12	14	25
Total	131	183	314	120	296	416	730

were collected carefully, and immediately fixed in 10% formalin.

In the laboratory, the flat along the central axis of the earplug was cut using a sharp blade, then it was placed on a wet stone to expose the neonatal line and growth layers (Figure 3). Growth layers were counted under water using a stereoscopic microscope. A growth layer group (GLG) was defined as one pair of light and dark laminae in the core and considered as one year of age. Age reading was conducted in the following manner: i) earplug of the

left side was read. If the growth layers were ambiguous, earplug from the right side was also read. Reading from the less ambiguous side was adopted; ii) age reading was conducted only once without any knowledge of biological information such as body length or sex; iii) when the reading of all sample was completed, age data was compared with biological data such as body length or sexual maturity status, and some samples were re-read to check outlier, incomplete sample or invalid reading. All earplugs were read by a single reader (TB).

Estimation of biological parameters

Growth curve

To estimate growth curve, the von Bertalanffy growth model was fitted to the body length and age as:

$$L_t = L_\infty (1 - e^{-K(t-t_0)})$$

where L_t is the body length at age t , L_∞ is asymptotic length, K is the growth rate coefficient and t_0 is the theoretical time at zero length.

Age at sexual maturity

Age at sexual maturity (tm) was estimated by the following equation (Cooke, 1984):

$$tm = l - 0.5 + \sum_l^k \left(\frac{I_a}{N_a} \right)$$

$$\text{var}(tm) = \sum_l^k \frac{M_a I_a}{N_a^2 (N_a - 1)}$$

where

- M_a is number of mature animals in age a
- I_a is number of immature animals in age a
- N_a is total number of animals in age a
- l is age of youngest mature animal in the sample
- k is age of oldest immature animal in the sample.

Ovulation rate

Annual ovulation rate was estimated by applying linear regression analysis between age and total number of corpora (corpora lutea and albicantia). The regression line was fitted to age 10 and older because almost all animals mature at the age of 10.

RESULTS AND DISCUSSIONS

Age readability

The readability of earplugs varied depending on the maturity status. Readability of sexually immature individuals was 46.6% for males and 40.8% for females (Table 2). Readability of earplugs in sexually mature animal was higher, 76.5% and 76.4% for males and females, respectively (Table 2). Readability of all samples was 65.2%, which was higher than that of western North Pacific common minke whales (44.1%) (Maeda *et al.*, 2016), and

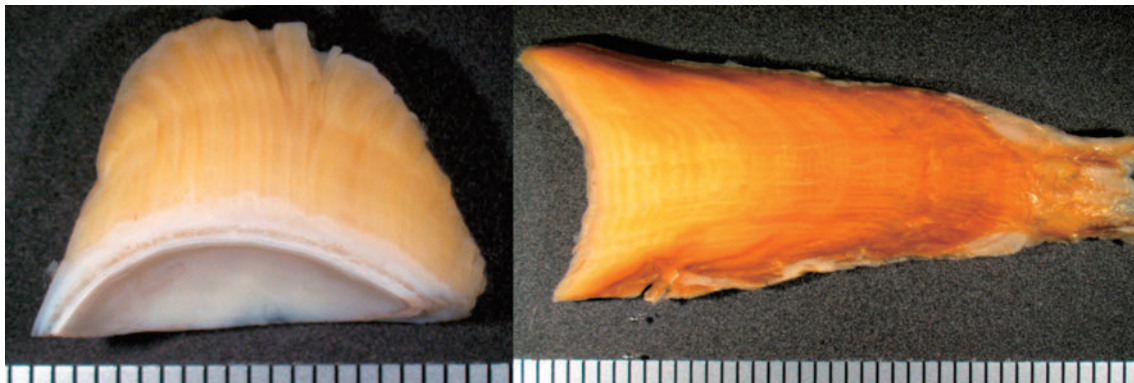

Figure 3. Bisected earplug surfaces of Bryde's whales (left: 5 GLGs, right: 20 GLGs). The scale shows 1 mm interval.

Table 2
Earplug-age readability of Bryde's whales by sex and sexual maturity status.

	Male			Female			Total		
	Number of whales	Readable earplugs	Readability (%)	Number of whales	Readable earplugs	Readability (%)	Number of whales	Readable earplugs	Readability (%)
Immature	131	61	46.6	120	49	40.8	251	110	43.8
Mature	183	140	76.5	296	226	76.4	479	366	76.4
Total	314	201	64.0	416	275	66.1	730	476	65.2

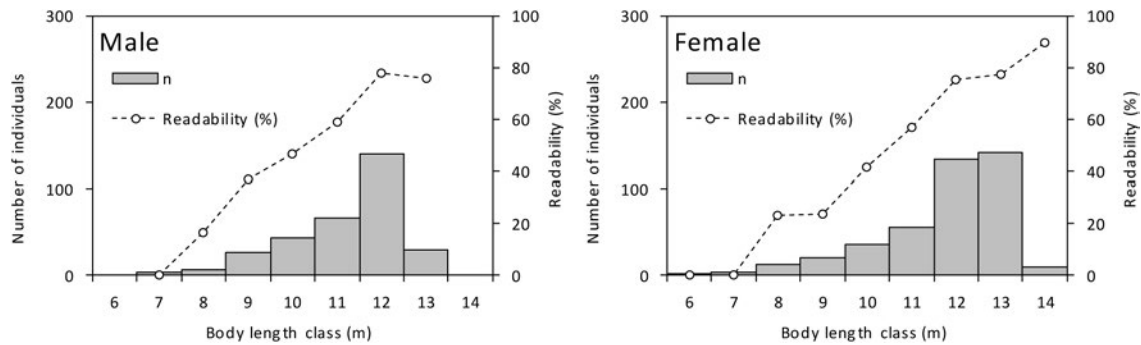

Figure 4. Earplug age readability of Bryde's whales by body length class and sex.

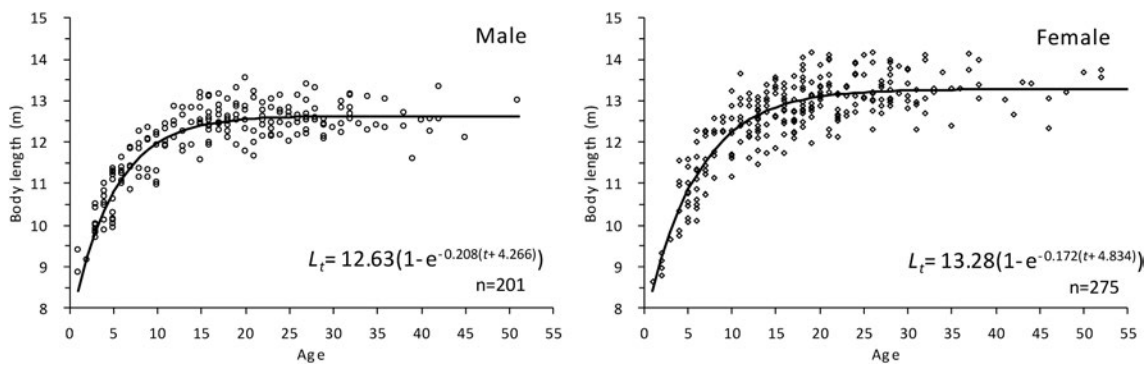

Figure 5. Relationship between body length and age of Bryde's whales. The solid line shows the von Bertalanffy growth curve.

was comparable to that of sei whales (63.0%) (Bando *et al.*, 2016), which were estimated based on samples collected by JARPN/JARPNII.

Readability increased with body length for both sexes (Figure 4). An inter-reader calibration experiment, following the method of Kitakado *et al.* (2013), will be conducted in the near future.

Growth curve

For both sex, the growth rate was high at younger ages and stabilized after 20 years old (Figure 5). The following von Bertalanffy growth curves were estimated:

$$\text{Male: } L_t = 12.63(1 - e^{-0.208(t+4.266)})$$

$$\text{Female: } L_t = 13.28(1 - e^{-0.172(t+4.834)})$$

Ohsumi (1977) estimated growth curves of Bryde's whales based on samples collected by the commercial whaling in the North Pacific, and estimated maximum length as 12.8 m (42 ft) and 13.4 m (43.8 ft) for males and females, respectively. Similar values were obtained for Bryde's whales sampled by JARPNII.

Age at sexual maturity

Sexually mature males first appeared at the age of 8, and from 16 years old all animals were sexually mature (Figure 6). Age at sexual maturity (t_m) for males was esti-

mated as 10.24 years (SE=0.60).

Sexually mature females first appeared at the age of 7, and from 11 years old all animals were sexually mature (Figure 6). t_m was estimated as 8.56 years (SE=0.39).

Ohsumi (1977) reported age at 50% sexual maturity of Bryde's whales collected by the commercial whaling in the North Pacific in the 1970's as 10 and 8 years for males and females, respectively. Consideration should be given to the possibility of bias arising from legal size limit and the selectivity of large animals during commercial whaling. However similar estimates were obtained for Bryde's whales collected during past commercial whaling and JARPNII.

Annual ovulation rate

The corpora lutea/albicantia first appeared at the age of 7 and the number of corpora increased linearly after the age of 10 (Figure 7). Annual ovulation rate was calculated as 0.526. The estimated annual ovulation rate means that the majority of Bryde's whale in the North Pacific give birth (or ovulation occurs) every two years. The estimated value was higher than the 0.455 estimated from the 1970's commercial whaling (Ohsumi, 1977).

CONCLUDING REMARKS

It is concluded that substantial biological information was

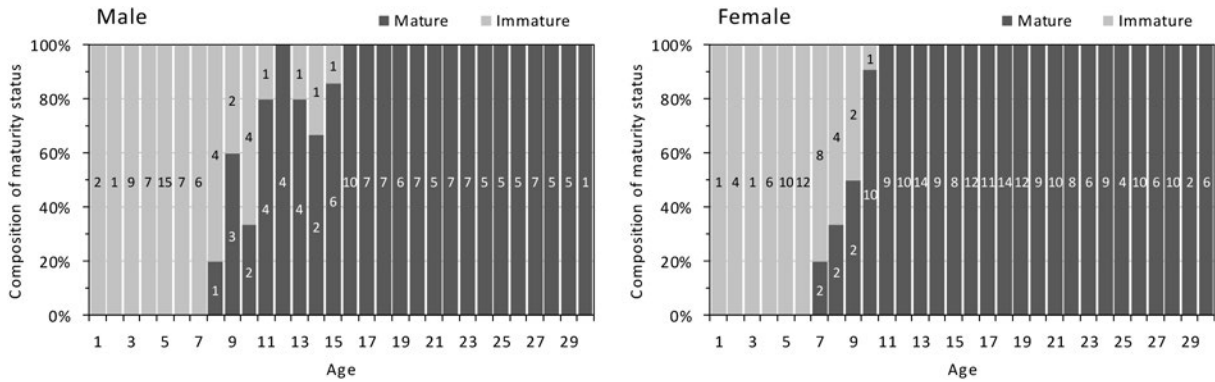

Figure 6. Sexual maturity status by age and sex in the Bryde's whales. Numbers in the bar shows the number of samples examined.

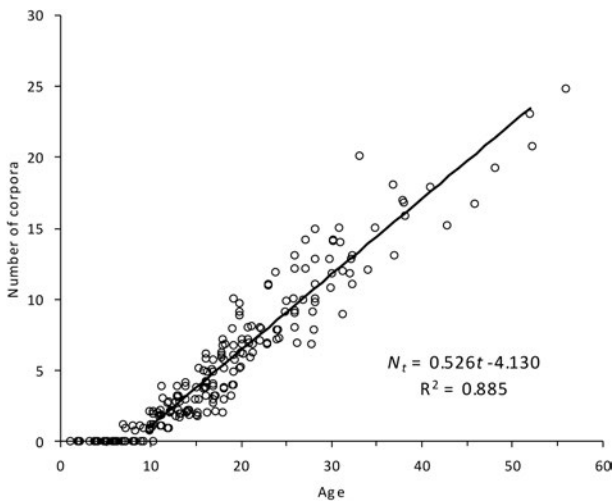

Figure 7. Relationship between age and number of corpora in Bryde's whales. Linear regression line was fitted to ages 10 and more.

obtained for the North Pacific Bryde's whales during the 17 years of JARPNII. In particular the readability of earplugs for age determination increased notably compared to that in the period of commercial whaling. The analyses of biological data will contribute to the management of this whale species in the North Pacific for example by incorporating such data into the conditioning process of the RMP *Implementation Simulation Trials* (Bando and Kato, 2017).

ACKNOWLEDGEMENTS

Our sincere thanks are due to all researchers and crews that collected data and samples during the JARPNII surveys. Kazuyoshi Nakai (ICR) helped in the preparation of earplugs for age determination.

REFERENCES

Bando, T., Maeda, H., Ishikawa, Y., Kishiro, T. and Kato, H. 2016. Preliminary report on progress in earplug-based age deter-

mination of sei whales collected during 2002 to 2013 JARPNII survey. Paper SC/F16/JR55 presented to the JARPNII special permit expert panel review workshop, Tokyo, February 2016 (unpublished). 3 pp. [Available from the IWC Secretariat].

Bando, T. and Kato, H. 2017. Report on progress in earplug-based age determination and estimation of biological parameters of Bryde's whales collected during 2000 to 2014 JARPNII surveys. Paper SC/MAR17/RMP/03 presented to the Workshop on the RMP *Implementation Review* of offshore western North Pacific Bryde's whales, Tokyo, March 2017 (unpublished). 9 pp. [Available from the IWC Secretariat].

Cooke, J.C. 1984. The estimation of mean ages at sexual maturity from age sample. Paper SC/36/O22 presented to IWC Scientific Committee, 1984 (unpublished). 8 pp. [Available from the IWC Secretariat].

Government of Japan. 2000. Research plan for cetacean studies in the western North Pacific under special permit (JARPNII) (Feasibility study plan for 2000 and 2001). Paper SC/52/O1 presented to the IWC Scientific Committee, 2000 (unpublished). 68 pp. [Available from the IWC Secretariat].

Government of Japan. 2002. Research plan for cetacean studies in the western North Pacific under special permit (JARPNII). Paper SC/54/O2 presented to the IWC Scientific Committee, 2002 (unpublished). 115 pp. [Available from the IWC Secretariat].

International Whaling Commission. 2017. Report of the Workshop on the *Implementation Review* of western North Pacific Bryde's whales, 21–24 March 2017, Tokyo, Japan. Paper SC/67a/REP/07 presented to the IWC Scientific Committee, May 2017 (unpublished). 37 pp. [Available from the IWC Secretariat].

Kato, H. and Perrin, W.F. 2017. Bryde's whales *Balaenoptera edeni/brydei*. pp. 158–163. In: B. Würsig, J.G.M. Thewissen and K. Kovacs (eds.) *Encyclopedia of marine mammals, Third Edition*. Academic Press, San Diego. 1190 pp.

Kershaw, F., Leslie, M.S., Collins, T., Mansur, R.M., Smith, B.D., Minton, G., Baldwin, R., LeDuc, R.G., Anderson, R.C., Brownell, R.L. and Rosenbaum, H.C. 2013. Population differentiation of 2 forms of Bryde's whales in the Indian and

- Pacific Oceans. *J. Hered.* 104 (6): 755–764.
- Kishiro, T. 1996. Movements of marked Bryde's whales in the western North Pacific. *Rep. Int. Whal. Commn.* 46: 421–428.
- Kitakado, T., Lockyer, C. and Punt, E.A. 2013. A statistical model for quantifying age reading errors and its application to the Antarctic minke whales. *J. Cetacean Res. Manage.* 13 (3): 181–190.
- Lockyer, C. 1984. Age determination by means of the earplug in baleen whales. *Rep. Int. Whal. Commn.* 34: 692–696.
- Maeda, H., Bando, T., Kishiro, T., Kitakado, T. and Kato, H. 2016. Basic information of earplug as age character of common minke whales in western North Pacific. Paper SC/F16/JR53 presented to the JARPNII special permit expert panel review workshop, Tokyo, February 2016 (unpublished). 10 pp. [Available from the IWC Secretariat].
- Ohsumi, S. 1977. Bryde's whales in the pelagic whaling ground of the North Pacific. *Rep. Int. Whal. Commn.* (Special Issue 1): 140–148.
- Omura, H. 1963. An improved method for collection of earplugs from baleen whales. *Norsk Hvalfangst-Tidende* 10: 279–283.
- Yoshida, H. and Kato H. 1999. Phylogenetic relationships of Bryde's whales in the western North Pacific and adjacent waters inferred from mitochondrial DNA sequences. *Mar. Mamm. Sci.* 15: 1269–1286.
- Wada, S., Oishi, M. and Yamada, T. 2003. A newly discovered species of living baleen whale. *Nature* 426: 278–281.

Technical Report (not peer reviewed)

Biological observations of fin whales sampled by JARPAII in the Indo-Pacific region of the Antarctic

Toshihiro MOGOE*

Institute of Cetacean Research, 4–5 Toyomi-cho, Chuo-ku, Tokyo 104–0055, Japan

*Contact e-mail: mogoe@cetacean.jp

ABSTRACT

A limited number of fin whales ($n=17$) was sampled during the JARPAII surveys in the Indo-Pacific region of the Antarctic in the austral summer seasons between 2005/06 and 2010/11. This paper summarizes the biological information obtained from those whales such as body proportion, reproductive status, age/length relationship, body length/body weight relationship and ecological markers (external parasites). Some of the biological information was compared with data from the commercial whaling period. The main results were that body weights of whales in the JARPAII period are heavier than those reported in the 1950's. Results suggested the possibility that whales are reaching sexual maturity at younger ages, which is consistent with the reported increase in the abundance in recent decades. Given the small sample size, these results should be considered as preliminary.

INTRODUCTION

The fin whale, *Balaenoptera physalus* (Linnaeus, 1758) was one of the main target species of commercial whaling during the 20th century, and populations reached critical levels after overexploitation. The species was protected in 1976 (IWC, 1977).

More than 40 years have passed since the ban of commercial whaling of fin whales in the Antarctic. As an effect of the protection measures, in recent years abundance of this species in the Indo-Pacific region of the Antarctic has been increasing at annual rates of 13–16% based on JARPA sighting data obtained from the austral summer season 1987/1988 (Matsuoka *et al.*, 2005; Matsuoka *et al.*, 2006). Information on biological parameters is important for assessment and management but biological data of this species have not been available since 1976. Changes in biological parameters such as pregnancy rate, sexual maturity rate, and age at sexual maturity changes are density-dependent (Gambell, 1973; Kato, 1986).

A limited number of fin whales ($n=17$) was sampled during the JARPAII surveys in the Indo-Pacific region of the Antarctic in the austral summer seasons between 2005/06 and 2010/11 (GOJ, 2005). Detailed biological examinations were conducted on these whales. The objective of this paper was to summarize the biological information collected. These are the only available biological data from fin whales in the Antarctic after the commercial

whaling operations stopped some 40 years ago. Some of the biological information was compared with data in the commercial whaling period.

MATERIALS AND METHODS

Samples

Catch records and biological data of the 17 whales sampled are shown in Table 1. The geographical distribution of the catches is shown in Figure 1. The body weight of one individual (0506F001) was not obtained because of some technical reasons. Another individual (0607F001) was lost before landing on the deck of the research base vessel and no measurements could be obtained.

Biological data

External measurements

The external measurements were conducted based on previous protocols (Mackintosh and Wheeler, 1929; Laws, 1961), modified by the Institute of Cetacean Research (ICR). Figure 2 shows the external measurements obtained. Figure 3 shows a fin whale being measured on-board the research base vessel. Body length was defined as the body axes length from the tip of snout to notch of flukes in parallel to the plane of the deck.

Ventral grooves

The number of ventral grooves was counted following Williamson (1973).

Table 1
Catch records and biological data of the fin whales sampled in the JARPAIL.

Serial No.	Catch date	Catch position		Sex	Sexual maturity	Body length (m)	Body weight (t)	Age (yrs)	Foetus sex	Foetus body length (cm)
		Latitude	Longitude							
0506F001	030206	65°44S	71°38E	M	Immature	19.17	—	9		
0506F002	080206	65°54S	78°06E	F	Mature	20.05	53.48	11	Male	127.5
0506F003	090206	65°48S	78°07E	F	Mature	19.47	52.05	12	Female	280.7
0506F004	100206	65°37S	78°13E	M	Mature	18.73	41.87	22		
0506F005	130206	65°22S	82°00E	M	Mature	19.14	47.28	11		
0506F006	140206	65°10S	81°59E	F	Immature	19.15	47.04	9		
0506F007	070306	64°34S	111°51E	F	Mature	20.22	61.52	7		
0506F008	090306	64°53S	114°06E	F	Immature	18.22	41.06	7		
0506F009	100306	64°48S	114°14E	M	Immature	18.30	42.27	6		
0506F010	130306	65°36S	120°30E	F	Immature	19.35	47.24	8		
0607F001	030107	63°53S	170°44W	F	—	—	—	—	—	—
0607F002	050107	62°35S	174°17W	M	Mature	20.67	51.62	11		
0607F003	020207	68°46S	173°41W	F	Mature	21.15	65.02	10	Male	243.4
0809F001	130309	65°38S	165°08E	F	Immature	14.79	22.26	6		
0910F001	030210	66°08S	62°32E	M	Immature	17.61	34.20	6		
1011F001	070111	63°28S	175°40W	M	Mature	19.05	39.63	12		
1011F002	200111	66°39S	165°32E	M	Mature	18.99	43.78	10		

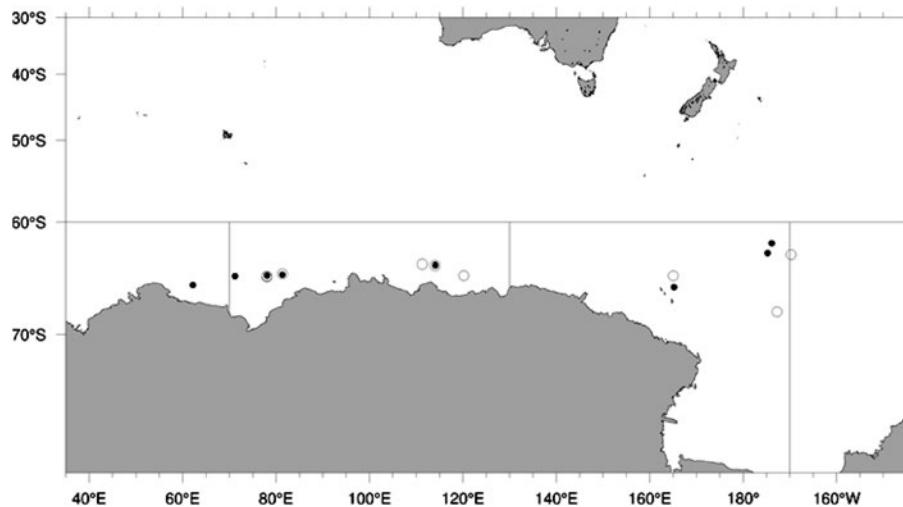

Figure 1. Geographical distribution of fin whales sampled during JARPAIL surveys. Closed circle: female; open circle: male.

Body weight

Body weights were measured by summing all body parts using an electronic hanging scale (maximum capacity of 30t) and marine scale (M1100, Marel, Iceland).

Reproductive data

Three individuals (0506F002, 0506F003 and 0607F003) were pregnant. Their foetuses were measured and sampled in the same manner as adult whales.

In females, both ovaries were removed and weighed together. In males, testes were removed from both sides

and weighed separately. The gonads weight was measured by using the electronic marine scale (S-182, Marel, Iceland).

The sexual maturity of females was determined by the presence of corpus luteum or corpus albicans in either ovary. In the case where no corpus luteum or corpus albicans was observed in both ovaries, the female was categorized as sexually immature. Conversely, if at least one corpus luteum or corpus albicans was observed in either or both ovaries, the female was categorized as sexually mature. The counting of the corpus luteum and

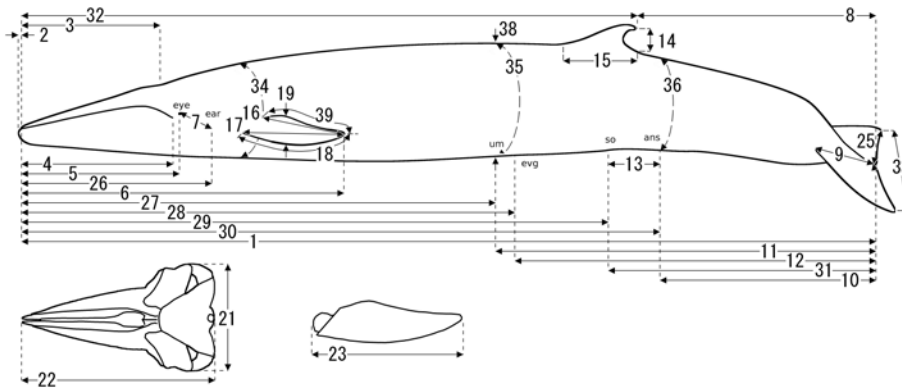

Figure 2. Measurement points of external proportions of fin whale in the JARPAII. 1: total length; 2: lower jaw, projection beyond tip of snout; 3: tip of snout to blowhole; 4: tip of snout to angle of gape; 5: tip of snout to centre of eye; 6: tip of snout to tip of flipper; 7: eye to ear; 8: notch of flukes to posterior emargination of dorsal fin; 9: flukes, width at insertion; 10: notch of flukes to anus; 11: notch of flukes to umbilicus; 12: notch of flukes to end of ventral grooves; 13: anus to reproductive aperture; 14: dorsal fin, vertical height; 15: dorsal fin, length of base; 16: flipper, tip to axilla; 17: flipper, tip to anterior end of lower border; 18: flipper, length along curve of lower border; 19: flipper, greatest width; 20: not available; 21: skull, greatest width; 22: skull length, condyle to tip of premaxilla; 23: flipper, tip to head of humerus; 24: not available; 25: flukes, notch to tip; 26: tip of snout to centre of ear; 27: tip of snout to centre of umbilicus; 28: tip of snout to end of ventral grooves; 29: tip of snout to centre of reproductive aperture; 30: tip of snout to anus; 31: notch of flukes to centre of reproductive aperture; 32: tip of snout to posterior emargination of dorsal fin; 33: width of flukes; 34: girth of chest, half; 35: girth of abdominal, half; 36: girth of buttock, half; 37: not available; 38: body height of navel; 39: border length posterior end to tip of flipper.



Figure 3. Body measurements of fin whale No. 1011F001 on the deck of the research base vessel.

corpus albicans was not carried out because the ovary samples were lost after the earthquake and tsunami on 11 March 2011.

The male sexual maturity was determined by the weight of testis. If one testis was over 2.5 kg, the whale was determined as sexually mature (Ohsumi, 1964).

Figure 4 shows ovaries and testes of Antarctic fin whales examined in this study.

Age determination

The age was determined by counting of growth layers in the earplugs (Purves, 1955; Ohsumi, 1964; Lockyer, 1972; Maeda *et al.*, 2013). The left and right earplugs were collected carefully using scalpel, and immediately fixed in 10% formalin until age determination. After slicing the surface of earplugs by use of whetstone, the layers were counted using a stereoscopic microscope under low magnification (3.15–31.5x, Figure 5). One pair of the light and dark laminae in the core of the earplug corresponds to one year, according to evidence from Ohumi (1964) and optimized histochemical method of Maeda *et al.* (2013).

Marine diatom

Quantitative measurements of attached marine diatoms on the whale body (five categories) were made following Omura (1950).

Parasites

Observation of internal/external parasites was carried out.

Analytical procedures

Fin whale data obtained by JARPAII were compared with published Japanese commercial whaling data obtained in the Antarctic in the late 1940s and early 1950s. Table 2

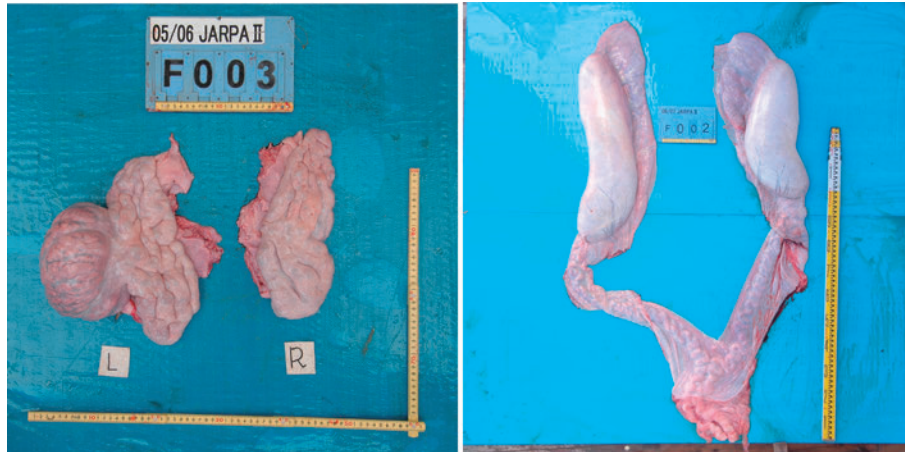

Figure 4. A pair of ovaries of fin whale individual No. 0506F003 (left) and a pair of testes with epididymis of fin whale individual No. 0607F002 (right).



Figure 5. Earplug of fin whale individual No. 0506F001 after slicing the surface.

shows the number of samples used for the comparative analysis. The following biological data were used in the comparison.

Body proportion

The mean values (\pm SD) of JARPAII were calculated and compared through plotting data on the normalized axis using Japanese commercial whaling data.

Relationship between body length and body weight/organ weight

The relationship between body length and body weight was evaluated by applying single nonlinear regression. The following formula was used (Lockyer, 1976):

$$\text{Body weight (t)} = a \text{ Body length (m)}^b$$

The coefficient of a and b were estimated by the least-squares method.

Comparison between body length and body part weights was carried out using samples from 34 fin whales

from Japan's commercial whaling data. These data were calculated on mean (\pm SD) value in each class of 1 m body length.

In order to check whether there are differences in reproductive condition, we compared the relationship body length/gonad weight using the same data from body parts weight.

Relationship between body length and sexual maturity, and between age and sexual maturity

We estimated the age and length at sexual maturity by fitting a logistic regression to the proportion of mature female and male at age (length) x .

For body length and sexual maturity in JARPAII, there was no significant regression coefficient in the logistic model ($p=0.09$). Therefore estimates were based only on commercial whaling data in seasons 1949/1950s, 1950/1951s, and 1951/1952s.

For age and sexual maturity the same approach as described above was used. In this case the logistic model was based on both JARPAII and commercial whaling (1956/1957 season; Nishiwaki *et al.*, 1958). Each formula of logistic regression model was used:

$$p = \frac{e^{\beta_1 x_1 + \beta_2 x_2 + \dots + \beta_p x_p + \beta_0}}{1 + e^{\beta_1 x_1 + \beta_2 x_2 + \dots + \beta_p x_p + \beta_0}}$$

p : predicted value, x : independent variable, e : base of natural logarithm, β : parameter.

RESULTS

Biological information from JARPAII

Sex ratio and body weight

Of 17 whales sampled nine were females (male sex ratio: 0.47). Mean body weight was 46.02t (SD: 10.47). The maximum and minimum weights for females were 65.02t

Table 2

Number of samples, period of sampling and source of data used in the comparative analysis of fin whales between JARPAII and past commercial whaling.

Items	JARPAII	Commercial whaling		
	Samples	Samples	Season	Source
Body proportion	16	16	1948/1949	Fujino (1954)
		6	1949/1950	Fujino (1954)
		5	1950/1951	Fujino (1954)
Body length and weight	16	16	1947/1948	Nishiwaki (1950)
		13	1948/1949	Nishiwaki (1950)
		5	1950/1951	Ohno and Fujino (1952)
Organ weight	15	16	1947/1948	Nishiwaki (1950)
		13	1948/1949	Nishiwaki (1950)
		5	1950/1951	Ohno and Fujino (1952)
Body length and gonad weight	16	16	1947/1948	Nishiwaki (1950)
		13	1948/1949	Nishiwaki (1950)
		5	1950/1951	Ohno and Fujino (1952)
Body length and maturity	16	437	1949/1950	Mizue and Murata (1951)
		2,049	1950/1951	Ohno and Fujino (1952)
		2,583	1951/1952	Kakuwa <i>et al.</i> (1953)
Age and maturity	16	288	1956/1957	Nishiwaki <i>et al.</i> (1958)
Body length	16	535,740	1930/1931–1975/1976	International Whaling Statistics

and 22.26t, respectively. The maximum and minimum weights for males were 51.62t and 34.20t, respectively (Table 1).

Sexual maturity

Sexual maturity rate was 50.0% (4/8) and 62.5% (5/8) for female and males, respectively. The three pregnant whales had a single foetus, and a single corpus luteum existed on one ovary. During the dissection of all female whales, no milk was found in the mammary glands. As shown in Table 1, body lengths of foetuses were 280.7 cm (female), 127.5 cm (male) and 243.4 cm (male). Their body weights were 172.0 kg, 20.00 kg, and 141.0 kg, respectively. No abnormalities were observed in the fetuses.

Ventral grooves

The mean number of ventral grooves was 67 (SD: 10) in males and 69 (SD: 5) in females.

Marine diatom

In most cases diatom film was recognized on the surface of the whale body (14 of 16 whales). Adhesions of diatom films were more densely observed in males than females

Table 3

The adhesion level of diatom films of the body of fin whales sampled by JARPAII.

Classification ¹	Female	Male	Total
–	2	0	2
±	0	0	0
+	6	6	12
++	0	2	2
+++	0	0	0
Total	8	8	16

¹ –: not infected; ±: with thin film; +: with patched; ++: with thick film; +++: with thick film on whole body.

(category ‘+++’ in Table 3).

Parasites

Table 4 shows the frequency of external parasites. The most observed sessile organisms on the skin were *Cyamus* (44.0%). 75.0% of males and 12.5% of females had *Cyamus* on the ventral grooves. Chi-square test revealed that the percentage of attachments of *Cyamus* significantly differed by sex ($p < 0.05$). Neither *Pennella* nor *Conchoderma* were observed. *Coronula sp.* was observed

in males and females with the same percentage.

Internal parasites were not observed in the stomachs of 16 fin whales. Unidentified parasites were observed in the Gastroepiploic.

Comparative analyses

Average body length

Mean body length for female whale sampled in JARPAII was 19.05 m (SD: 1.92) (maximum and minimum lengths were 21.15 m and 14.79 m, respectively). Mean body length for male whales sampled in JARPAII was 18.96 m (SD: 0.87) (maximum and minimum lengths were 20.67 m and 18.61 m, respectively).

Body length (m) of each fin whale sampled in JARPAII is plotted in Figure 6 with annual mean length and \pm SD of fin whales captured in Antarctic pelagic whaling during the periods 1930/1931–1975/1976.

It is difficult to compare the data between the commercial and JARPAII, because there was a regulation for size limit of 70ft (21.34 m) for the fin whale in pelagic

commercial whaling. On the other hand, for technical reasons it was not possible to take fin whales of more than 20 m in JARPAII. Notwithstanding these difficulties, a decreasing trend in the average body length is observed for the years of commercial whaling (Figure 6).

Body proportion

The mean value and body proportion of the external measurements of JARPAII is summarized in Table 5, by sex. As shown in this table, no difference in proportions was observed between the sexes except for the reproductive aperture (e.g. measurement point 13).

In order to clarify the JARPAII properties of body proportions, a data chart was created using the mean value and the standard deviation for 15 measurement locations of Japanese commercial whaling data (Figure 7). JARPAII data are smaller than Japanese commercial whaling data in many parts in both sexes. In measurements points 7, 14, and 21 in JARPAII, males are larger than commercial whaling data. Females are larger than males in many points. Excepting for sex difference, dorsal fin is higher, and the skull is shorter than commercial whaling data. This trend was particularly pronounced in males.

Relationship between body length and body weight

Figure 8 shows the relationship between body length and body weight for JARPAII and commercially caught fin whales. Calculated coefficients a and b in the formula are $a=0.005394\pm0.005329$ and $b=3.068448\pm0.332619$ in JARPAII, and $a=0.044530\pm0.027880$ and $b=2.315830\pm0.205040$ in commercial data. From the graph, predicted body weights of fin whale captured in JARPAII tend to be

Table 4

Infection rate of external parasites and diatom films in fin whales collected from JARPAII.

Species	Male ¹	Female ¹	Total ¹
<i>Cyamus</i>	6/8 (75.0)	1/8 (12.5)	7/16 (43.8)
<i>Coronula sp</i>	1/8 (12.5)	1/8 (12.5)	2/16 (12.5)
<i>Conchoderma sp</i>	0/8 (0.0)	0/8 (0.0)	0/16 (0.0)
<i>Pennella sp</i>	0/8 (0.0)	0/8 (0.0)	0/16 (0.0)
Diatom film	8/8 (100.0)	6/8 (75.0)	14/16 (100.0)

¹ infected/investigated (infected rate %)

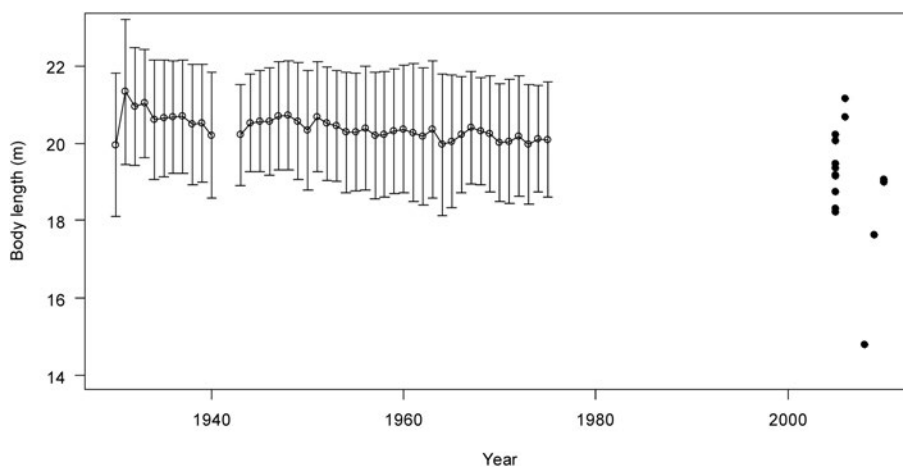

Figure 6. Yearly change in average body length of fin whale captured in Antarctic pelagic commercial whaling (open circle: seasons 1930/1931–1975/1976) and the body lengths of fin whale sampled in JARPAII (closed circle: seasons 2005/2006–2010/2011). Vertical bars indicate plus/minus one standard error. The data used in Antarctic pelagic commercial whaling were summarized from International Whaling Statistics.

Table 5
The external body proportions of the fin whales in the JARPAII (see Figure 2 for details).

	Males			Females		
	n	Mean	%BL	n	Mean	%BL
1. Body length (0.01 m)	8	18.96	100.0	8	19.05	100.0
2. Projection of snout (0.1 cm)	4	9.9	0.5	6	7.2	0.4
3. Snout-blow-hole (1 cm)	8	344	18.2	8	353	18.5
4. Snout-angle of gape (1 cm)	8	365	19.2	8	371	19.5
5. Snout-eye (1 cm)	8	372	19.6	8	382	20.1
6. Snout-tip of flipper (1 cm)	8	777	41.0	8	779	40.9
7. Eye-ear (0.1 cm)	8	91.4	4.8	8	91.1	4.8
8. Notch of flukes-dorsal fin (1 cm)	8	429	22.6	8	435	22.8
9. Notch of flukes-root of flukes (1 cm)	7	98	5.1	9	100	5.2
10. Notch of flukes-anus (1 cm)	8	535	28.2	8	532	27.9
11. Notch of flukes-umbilicus (1 cm)	8	860	45.4	8	860	45.1
12. Notch of flukes-ventral grooves (1 cm)	8	833	44.0	8	835	43.8
13. Anus-reproductive aperture (0.1 cm)	8	131.3	6.9	8	59	3.1
14. Height of dorsal fin (0.1 cm)	8	47.9	2.5	8	45	2.4
15. Length dorsal fin (0.1 cm)	8	108.3	5.7	8	102.1	5.4
16. Axilla-tip of flipper (1 cm)	8	149	7.9	8	151	7.9
17. Flipper length (1 cm)	8	230	12.1	8	230	12.1
18. Border length flipper (1 cm)	8	237	12.5	8	236	12.4
19. Width of flipper (0.1 cm)	8	52.8	2.8	8	52.3	2.7
21. Skull width (0.1 cm)	8	220.6	11.6	6	205.4	10.8
22. Skull length (0.1 cm)	8	464.5	24.5	8	475.6	25.0
23. Flipper length (from humerus) (1 cm)	8	239	12.6	5	245	12.9
25. Notch of flukes-flukes (1 cm)	4	215	11.3	3	226	11.9
26. Snout-ear (1 cm)	8	461	24.3	8	470	24.6
27. Snout-umbilicus (1 cm)	8	1032	54.5	8	1056	55.4
28. Snout-ventral grooves (1 cm)	8	1061	56.0	8	1055	55.4
29. Snout-reproductive aperture (1 cm)	8	1227	64.7	8	1311	68.8
30. Snout-anus (1 cm)	8	1358	71.6	8	1370	71.9
31. Notch of flukes-rep. aperture (1 cm)	8	664	35.0	8	589	30.9
32. Snout-dorsal fin (1 cm)	8	1460	77.0	8	1467	77.0
33. Width of flukes (1 cm)	8	407	21.5	8	426	22.4
34. Chest circumference, half (1 cm)	8	436	23.0	8	452	23.7
35. Abdominal circumference, half (1 cm)	8	345	18.2	8	366	19.2
36. Buttock circumference, half (1 cm)	8	260	13.7	8	277	14.5
37. Body height (0.1 cm)	7	182.6	9.6	8	195.4	10.3
38. Body height (0.1 cm)	8	246.6	13.0	8	254.8	13.4
39. Border leng. flipper (posterior) (1 cm)	8	154	8.1	8	156	8.2

Remarks. n: number of samples; %BL: percentage to body length; Mean: mean length.

heavier than that of the commercial whaling for the same body length.

Relationship between body length and organ weights

Figure 9 shows the relationship between body length and gonad weight. The relationship is very similar between JARPAII and commercially caught fin whale samples.

Tables 6a–b and 7a–b, and Figure 10 show the mean weights of each body part, by body length. Figure 10 shows that the body parts weight increase with body length. This increase is more pronounced in the case of the JARPAII whales for blubber (Figure 10b) and meat (Figure 10c). For bones and viscera the increasing pattern is similar between JARPAII and commercially caught whales.

Relationship between body length and sexual maturity

Figure 11 shows the relationship between body length and maturity rate of fin whales sampled by commercial whaling during the seasons 1949/1950, 1950/1951, and 1951/1952, for female and males. JARPAII samples

are plotted for both immature (0 rate) and mature (1.0 rate) individuals. Immature individuals of JARPAII ranged from 14.79 m to 19.35 m (17.61–19.17 m in males, 14.79–19.35 m in females). Mature individuals ranged from 18.73 m to 21.15 m (18.73–20.67 m in male, 19.47–21.15 m in female respectively).

It is estimated that the length at 50% sexual maturity is 18.99 m (18.69 m in male and 19.90 m in female) in commercial whaling samples. Regression coefficient

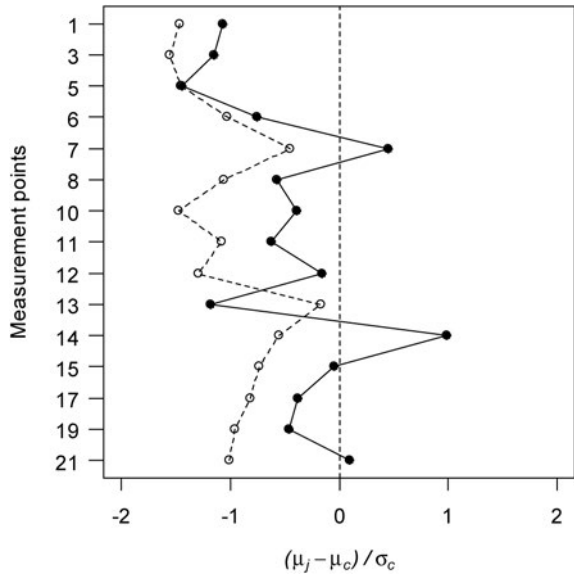

Figure 7. Body proportions of the JARPAII sample (closed circles and solid line: male; open circle and broken line: female). The data are plotted on the normalized axis using the data of Japanese commercial whaling (seasons 1948/1949–1950/1951). Measurement point key are shown in Figure 2. μ_j : mean value of JARPAII data; μ_c : mean value of the commercial whaling data; σ_c : standard deviation of the commercial whaling data.

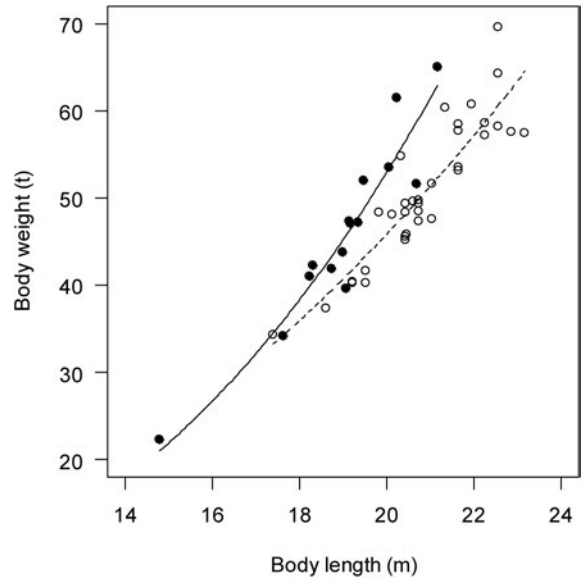

Figure 8. Relationships between body length and body weight in fin whales. Closed circles and solid line: JARPAII; open circles and broken line: Japanese commercial whaling (Nishiwaki, 1950; Ohno and Fujino, 1952: seasons 1947/1948–1950/1951).

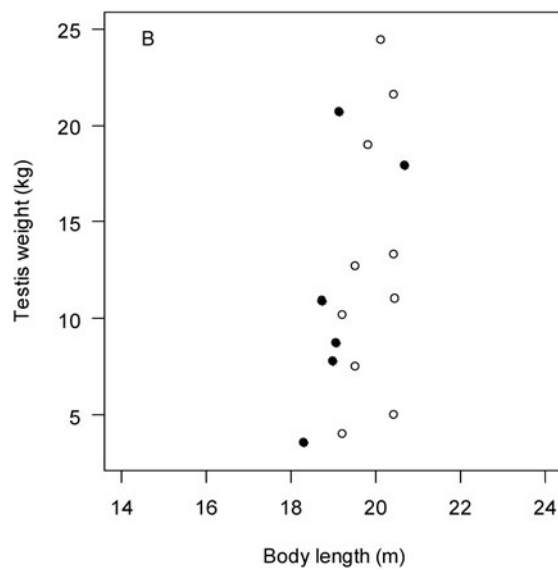
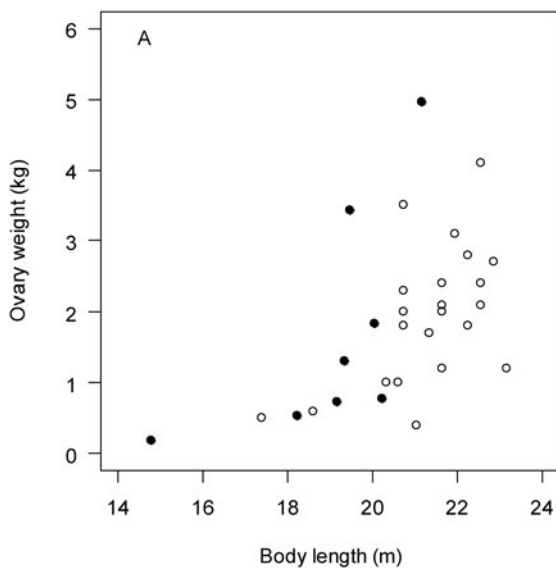

Figure 9. Relationship between body length and gonad weight. A: ovary weight; B: testis weight; closed circle: JARPAII; open circle: Japanese commercial whaling (Nishiwaki, 1950; Ohno and Fujino, 1952: seasons 1947/1948–1950/1951).

Table 6a
Average body parts weight (kg) of the fin whales in the JARPAII.

Class of body length (m)	Samples (female/male)	Total parts weight	Blubber	Meat	Bone	Viscera and others
14.0–	1 (1/0)	21,982.0	5,505.8	10,700.8	2,783.2	2,992.2
17.0–	1 (0/1)	33,996.0	7,779.1	17,080.4	4,879.5	4,257.1
18.0–	4 (1/3)	41,837.1	10,317.3	20,463.3	5,370.9	5,685.6
19.0–	5 (3/2)	46,090.3	11,678.0	22,318.7	5,918.1	6,175.5
20.0–	3 (2/1)	54,992.7	13,587.8	27,499.9	7,195.1	6,709.9
21.0–	1 (1/0)	63,999.3	16,745.8	31,439.0	7,287.7	8,526.8
Total	15 (8/7)	45,517.0	11,363.5	22,344.4	5,840.7	5,968.4

Table 6b
Percentage of body parts weight of the fin whales in the JARPAII.

Class of body length (m)	Samples (female/male)	Total parts weight	Blubber	Meat	Bone	Viscera and others
14.0–	1 (1/0)	100.0	25.0	48.7	12.7	13.6
17.0–	1 (0/1)	100.0	22.9	50.2	14.4	12.5
18.0–	4 (1/3)	100.0	24.7	48.9	12.8	13.6
19.0–	5 (3/2)	100.0	25.3	48.5	12.8	13.4
20.0–	3 (2/1)	100.0	24.7	50.0	13.1	12.2
21.0–	1 (1/0)	100.0	26.2	49.1	11.4	13.3
Total	15 (8/7)	100.0	25.0	49.1	12.8	13.1

Table 7a
Average body parts weight (kg) of the fin whales in commercial whaling data during the seasons 1947/1948–1950/1951.

Class of body length (m)	Samples (female/male)	Total parts weight	Blubber	Meat	Bone	Viscera and others
17.0–	1 (1/0)	33,817.0	6,953.0	16,875.0	4,899.0	5,123.0
18.0–	1 (1/0)	37,367.0	8,270.0	18,391.0	5,906.0	4,800.0
19.0–	5 (0/5)	43,712.0	10,263.8	19,473.6	7,760.2	6,214.4
20.0–	12 (6/6)	48,652.7	11,289.8	21,971.2	8,264.3	7,127.5
21.0–	8 (8/0)	55,629.7	12,761.0	25,914.0	8,856.8	8,098.0
22.0–	6 (6/0)	60,966.0	15,897.7	27,398.5	10,284.7	7,385.1
23.0–	1 (1/0)	57,487.6	13,319.0	24,093.0	9,132.0	10,943.6
Total	34 (23/11)	51,232.3	12,141.5	23,296.6	8,543.3	7,251.9

Table 7b
Percentage of body parts weight of the fin whales in commercial whaling data during the seasons 1947/1948–1950/1951.

Class of body length (m)	Samples (female/male)	Total parts weight	Blubber	Meat	Bone	Viscera and others
17.0–	1 (1/0)	100.0	20.5	49.9	14.5	15.1
18.0–	1 (1/0)	100.0	22.1	49.3	15.8	12.8
19.0–	5 (0/5)	100.0	23.5	44.5	17.8	14.2
20.0–	12 (6/6)	100.0	23.2	45.2	17.0	14.6
21.0–	8 (8/0)	100.0	22.9	46.6	15.9	14.6
22.0–	6 (6/0)	100.0	26.1	44.9	16.9	12.1
23.0–	1 (1/0)	100.0	23.2	41.9	15.9	19.0
Total	34 (23/11)	100.0	23.7	45.4	16.7	14.2

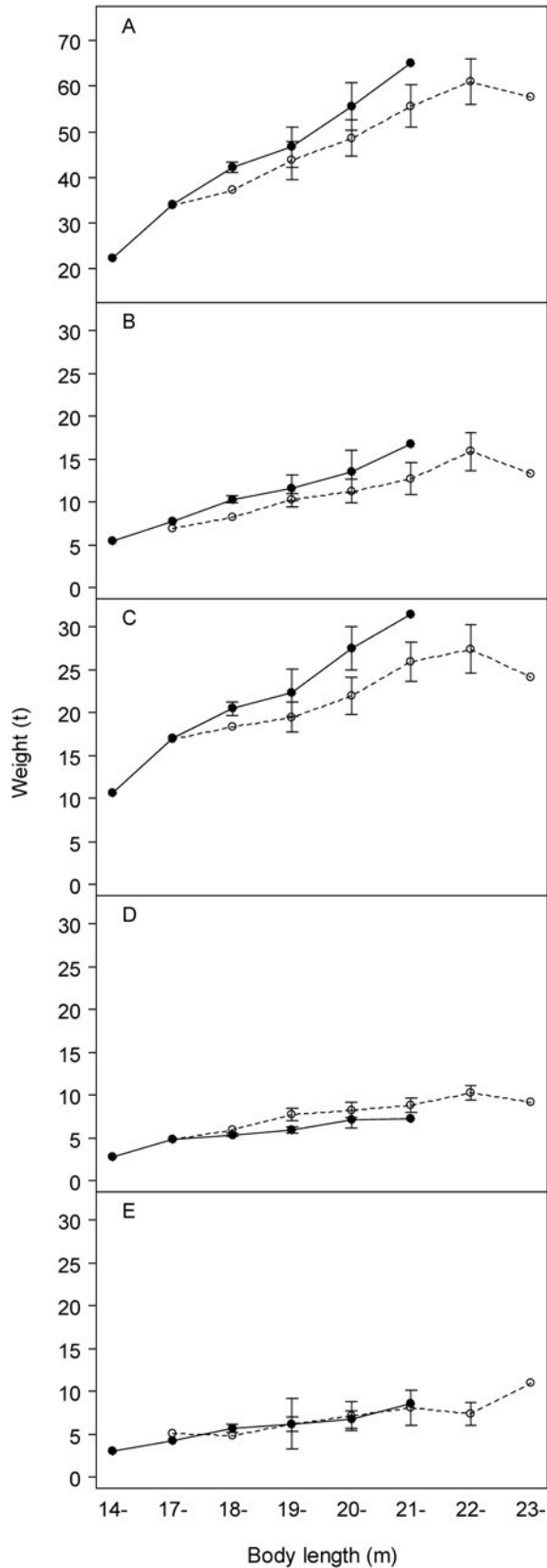

Figure 10. Comparison of the relationship body parts weight/body length between JARPAII (closed circle and solid line) and commercial whaling (open circle and broken line: seasons 1947/1948–1950/1951). A: body weight; B: blubber; C: meat; D: bones; E: viscera and others.

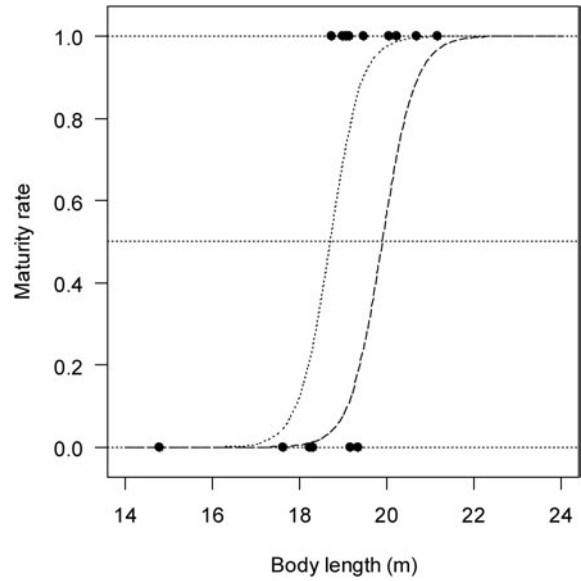

Figure 11. Relationship between body length and sexual maturity rate of the fin whales sampled by JARPAII (closed circle), and comparison of that with that from commercial whaling (broken line: female; dot line: male; seasons 1949/1950–1951/1952).

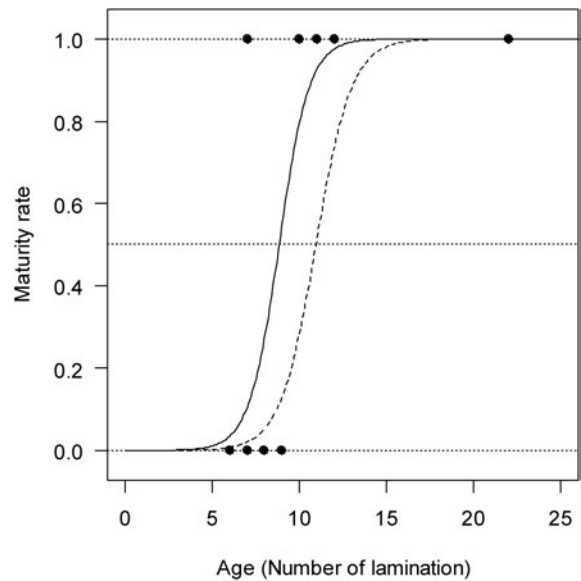

Figure 12. Relationship between age and sexual maturity rate of the fin whales sampled by JARPAII (closed circle and solid line), and comparison with that by commercial whaling (broken line: season 1956/1957).

between sexual maturity and body length of JARPAII did not reach statistical significance, possibly due to the small sample size. From the plotting, JARPAII data were equally distributed besides the rise of predicted probability of maturity rate in commercial whaling data except for immature one (body length=14.79 m).

Relationship between age and sexual maturity

Figure 12 shows the relationship between age and sexual maturity rate of fin whales sampled by JARPAII and commercial whaling during the season 1956/1957, for both sexes combined. Immature individuals of JARPAII ranged from 6 to 9 years old, and mature individuals ranged from 7 to 22 years old. It is estimated that the 50% sexual maturity age are 8.8 years old in JARPAII and 11.0 years old in commercial whaling, respectively. The minimum age of a pregnant whale obtained in JARPAII was 10 years old. Age at 50% sexual maturity of JARPAII is 2.2 years younger than Japanese commercial whaling data.

DISCUSSION

This study provided new biological information of fin whales in the Antarctic after 36 years of protection from commercial whaling. Although the number of whales examined was small some new and interesting results such as body proportion and parasites were obtained. During the commercial whaling period only large whales were taken. During the JARPAII survey there was the opportunity of sampling small animals for the first time. In fact the smallest whale was a 14.79 m whale and several biological data were obtained from this whale. The limitation of JARPAII, however, was for animals larger than 20.0 m which usually were not sampled because technical difficulties.

Body length/ body weight

It was found that Antarctic fin whales collected by JARPAII were heavier than those taken by commercial whaling in the 1950s. This might suggest that the feeding condition for the Antarctic fin whale has improved in recent years. It was also found that the relative weights of the blubber and the meat are heavier for fin whales sampled by JARPAII (Figure 10). The increase in body weight of fin whales, particularly in weight of meat and blubber, might indicate faster growth which was derived from better nutritional condition in recent years.

Body length and age at sexual maturity

There is the possibility that the age at sexual maturity of the fin whale has decreased in the 2000s. Decline in the age at sexual maturity in whales in response to substantial decrease in the abundance (for example due to over-exploitation) has been reported for sei and fin whales in part of the Indian Ocean and the Antarctic Ocean, and for fin whales in the northwest Pacific Ocean (Gambell, 1973; Lockyer, 1979; Ohsumi, 1986). Our study provided evidence that the age at sexual maturity of fin whales

sampled by JARPAII has decreased about 2.2 years from the 1950s.

The number of pregnant whales among the fin whales sampled by JARPAII was three out of four matured whales (75.0%). This high pregnancy rate was similar to the 1970s (Gambell, 1973).

All this evidence suggests improved nutritional conditions for fin whales in recent years. The biological studies based on JARPAII data were based on a small sample size. Further biological samples and data from this species will be needed to confirm the results found in this study.

ACKNOWLEDGEMENTS

I express my gratitude to the crew members and researchers that participated in the JARPAII surveys for hard work and excellent technical assistance. I also thank several ICR colleagues for providing suggestions on the analyses in this study.

REFERENCES

- Fujino, K. 1954. On the body proportions of the fin whales (*Balaenoptera physalus* (L)) caught in the northern Pacific Ocean (I) (Preliminary report). *Sci. Rep. Whales Res. Inst.* 9: 121–163.
- Gambell, R. 1973. Some effects of exploitation on reproduction in whales. *J. Reprod. Fertil. (Suppl.)* 19: 533–553.
- Government of Japan. 2005. Plan for the second phase of the Japanese whale research program under special permit in the Antarctic (JARPAII)—Monitoring of the Antarctic ecosystem and development of new management objectives for whale resources. Paper SC/57/O1 presented to the IWC Scientific Committee, June 2005 (unpublished). 99 pp. [Available from the IWC Secretariat].
- International Whaling Commission. 1977. Chairman's Report of the Twenty-Eighth Meeting. *Rep. int. Whal. Commn* 27: 22–35.
- Kakuwa, Z., Kawakami, T. and Iguchi, K. 1953. Biological investigation on the whales caught by the Japanese Antarctic whaling fleets in the 1951–52 season. *Sci. Rep. Whales Res. Inst.* 8: 147–213.
- Kato, H. 1986. Changes in biological parameters of Balaenopterid whales in the Antarctic, with special reference to southern minke whale. *Mem. Natl. Inst. Polar Res., Spec. Issue.* 40: 330–344.
- Laws, R.M. 1961. Reproduction, growth and age of southern fin whales. *Discovery Reports* 31: 327–486.
- Lockyer, C. 1972. The age at sexual maturity of the Southern fin whale (*Balaenoptera physalus*) using annual layer counts in the ear plug. *ICES Journal of Marine Science* 34 (2): 276–294.
- Lockyer, C. 1976. Body weights of some species of large whales. *ICES Journal of Marine Science* 36 (3): 259–273.
- Lockyer, C. 1979. Changes in a growth parameter associated

- with exploitation of southern fin and sei whales. *Rep. int. Whal. Commn* 29: 191–196.
- Maeda, H. Kawamoto, T. and Kato, H. 2013. A study on the improvement of age estimation in common minke whales using the method of gelatinized extraction of earplug. *NAMMCO Scientific Publications* [Online] 10. doi: 10.7557/3.2609.
- Mackintosh, N.A. and Wheeler, J.F.G. 1929. Southern blue and fin whales. *Discovery Reports* 1: 259–540.
- Matsuoka, K., Hakamada, T., Kiwada, H., Murase, H. and Nishiwaki, S. 2005. Abundance increases of large baleen whales in the Antarctic based on the sighting survey during Japanese whale research program (JARPA). *Global Environ. Res.* 9 (2): 105–115.
- Matsuoka, K., Hakamada, T., Kiwada, H., Murase, H. and Nishiwaki, S. 2006. Distributions and standardized abundance estimates for humpback, fin and blue whales in the Antarctic Areas III, IV, V and VIW (35°E–145°W), south of 60°S. Paper SC/D06/J7 presented to the JARPA Review Workshop, Tokyo (unpublished). 37 pp. [Available from the IWC Secretariat].
- Mizue, K. and Murata, T. 1951. Biological investigation on the whales caught by the Japanese Antarctic whaling fleets season 1949–50. *Sci. Rep. Whales Res. Inst.* 6: 73–131.
- Nishiwaki, M. 1950. On the body weight of whales. *Sci. Rep. Whales Res. Inst.* 4: 184–209.
- Nishiwaki, M., Ichihara, T. and Ohsumi, S. 1958. Age studies of fin whale based on earplug. *Sci. Rep. Whales Res. Inst.* 13: 155–169.
- Ohno, M. and Fujino, K. 1952. Biological investigation on the whales caught by the Japanese Antarctic whaling fleets, season 1950/51. *Sci. Rep. Whales Res. Inst.* 7: 125–190.
- Ohsumi, S. 1964. Examination on age determination of the fin whale. *Sci. Rep. Whales Res. Inst.* 18: 49–88.
- Ohsumi, S. 1986. Yearly change in age and body length at sexual maturity of a fin whale stock in the eastern North Pacific. *Sci. Rep. Whales Res. Inst.* 37: 1–16.
- Omura, H. 1950. Diatom infection on blue and fin whales in the Antarctic Whaling Area V (the Ross Sea area). *Sci. Rep. Whales Res. Inst.* 4: 14–26.
- Purves, P.E. 1955. The wax plug in the external auditory meatus of the Mysticeti. *Discovery Reports* 27: 293–302.
- Williamson, G.R. 1973. Counting and measuring baleen and ventral grooves of whales. *Sci. Rep. Whales Res. Inst.* 25: 279–292.

Technical Report (not peer reviewed)

Field and analytical protocol for the evaluation of novel non-lethal techniques in the Japanese whale research programs

Toshihiro MOGOE*

Institute of Cetacean Research, 4–5 Toyomi-cho, Chuo-ku, Tokyo 104–0055, Japan

*Contact e-mail: mogoe@cetacean.jp

ABSTRACT

This paper describes the ICR field and analytical protocol used to evaluate novel non-lethal techniques, which potentially can be used to respond to scientific questions related to NEWREP-A and NEWREP-NP. The protocol includes four primary questions, which should be responded to in order to evaluate the techniques. This paper also illustrates the use of this protocol to evaluate the use of faeces for studies of feeding ecology of whales (a non-lethal technique).

INTRODUCTION

The International Whaling Commission Scientific Committee (IWC SC) recommended that a field and analytical protocol should be developed to assist the evaluation of the utility of novel non-lethal techniques (IWC, 2016). Such techniques could potentially be used to respond to scientific questions related to the Japanese whale research programs (see Goto and Inoue, this issue). In response to this recommendation, scientists from the Institute of Cetacean Research (ICR) developed a protocol consisting of several questions that should be responded to in order to evaluate novel non-lethal techniques (see Mogoe *et al.*, 2015).

The objective of this paper is to describe this field and analytical protocol. The paper also illustrates the use of this protocol to evaluate the use of faeces for studies of feeding ecology of whales, a non-lethal technique.

DESCRIPTION OF THE FIELD AND ANALYTICAL PROTOCOL

The questions

The protocol consists of four questions, which are listed and explained in this section.

The first question (Q1) is whether a tissue or other kinds of samples can be obtained by a non-lethal technique (for example whether or not faeces can be collected from the sea surface during a research period).

The second question (Q2) is whether a sufficient number of samples for statistical analysis can be obtained by the non-lethal technique.

The third question (Q3) is whether the sample ob-

tained by the non-lethal technique can produce scientific information comparable to that produced by a lethal sampling technique.

The fourth question (Q4) is whether the cost for obtaining the sample and for producing scientific information from the sample is reasonable.

Q1 and Q2 above are technical in nature. Q3 is analytical while Q4 is of a logistic nature.

Formulating the questions to evaluate a non-lethal technique

The flow chart of Figure 1 shows a systematic application of the protocol to evaluate a novel non-lethal technique. The fundamental question to be responded to through this chart is whether a novel non-lethal technique can replace the lethal-sampling.

The formulation of the four questions forms a basis to objectively discuss the feasibility and practicability of non-lethal techniques, particularly from a perspective of whether particular research objectives are achievable through non-lethal techniques.

Criteria for questions

The criteria for Q1 is simple. If at least one tissue or sample can be taken during the research period by the non-lethal technique, the answer is 'yes' otherwise the answer is 'no.'

For Q2 the sampling efficiency of a non-lethal technique needs to be compared with that of a lethal technique. For example in the case of faeces sampling (see below), the number of samples collected by some unit of effort is compared with the number of whales (stomachs)

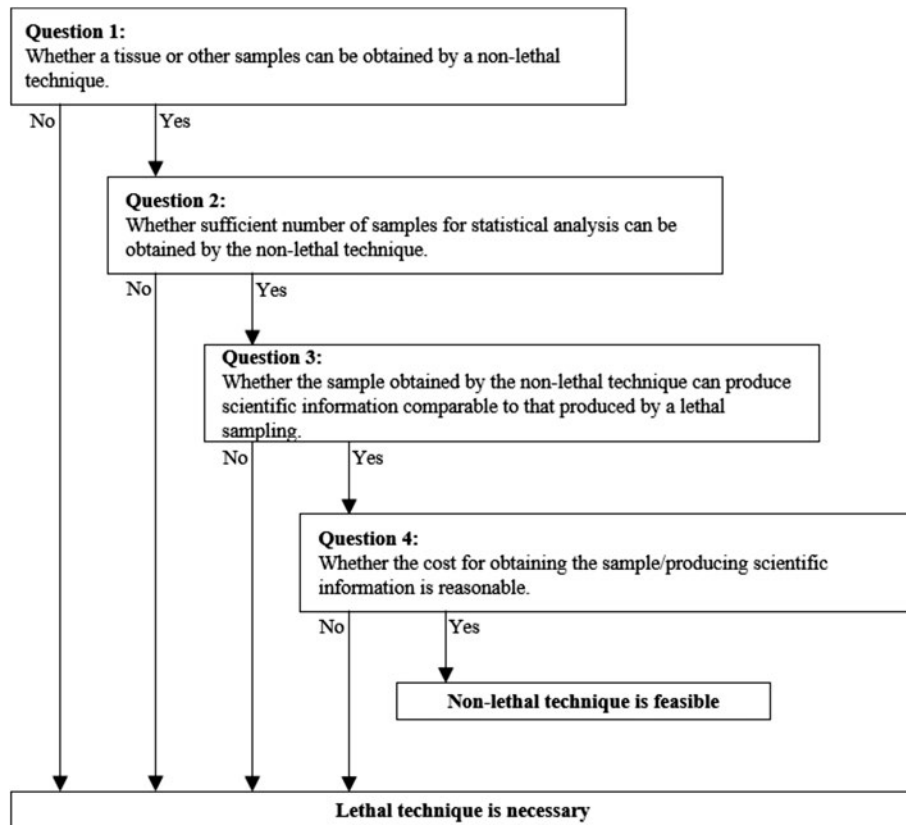

Figure 1. Systematic application of the four questions to evaluate the feasibility of novel non-lethal techniques.

sampled by the same unit.

In Q3 the key issue is whether the analysis of the tissue or samples obtained by the non-lethal technique can respond to specific scientific questions by producing scientific information of similar or better quality than that produced by the lethal-technique. For example in the case of faeces samples (see below), the key question will be whether the analysis of faeces samples can produce similar or better scientific information than the lethal technique (stomach content analysis) to respond questions of prey consumption (qualitative and quantitative) and prey preference, which are important input data for ecosystem models.

Criteria for Q4 require further consideration but the simplest approach for an evaluation could be dividing the overall cost for research by the number of samples obtained.

APPLICATION OF THE PROTOCOL TO EVALUATE THE USE OF FAECES FOR FEEDING ECOLOGY STUDIES

Currently reliable information on prey consumption and prey preferences of whales is obtained through the analyses of stomach contents. The fundamental question is whether the analysis of faeces samples can provide such reliable information.

Field and laboratory data were obtained, which are explained below. Data collected were the basis of responses to the four questions in Figure 1.

Field data

The field experiments on the evaluation of the faeces sampling for studies of feeding ecology of North Pacific common minke, Bryde's and sei whales were carried out during the 2014 and 2015 JARPNII surveys. *Yushin Maru*-type vessels were used for the experiments in the offshore component of JARPNII (Bando *et al.*, 2016) (sighting and sampling vessels: SSVs, and sighting vessels: SVs). Smaller vessels were used in the coastal component (Kishiro *et al.*, 2016).

Table 1 shows a summary of the effort (time) spent on both whale observation and sampling (lethal) and faeces observation and sampling (non-lethal).

Observation and sampling of faeces

Observation of excretion and sampling of faeces in identified individuals of common minke, sei and Bryde's whales were made from the platforms of the survey vessels. The effort was defined as the observation time from confirmation of the whale species (0.2 n.miles) to the end of observation/sampling. If an observer found faeces near the sea surface, the faeces were sampled by circle net

Table 1

Effort (hours) spent in whale observation and sampling (lethal) and faeces observation and sampling (non-lethal) surveys. See text for details.

	Offshore SSVs	Offshore SVs	Coastal Sanriku	Coastal Kushiro
2014 JARPNII				
Whale observation and sampling effort	193.3	—	510.3	250.9
Faeces observation and sampling effort	89.6	262.4	60.8	58.6
Total effort	282.9	262.4	571.1	309.5
Rate (%) of non-lethal effort	31.7	100.0	10.6	18.9
2015 JARPNII				
Whale observation and sampling effort	61.5	—	596.4	521.7
Faeces observation and sampling effort	99.5	547.5	54.6	65.4
Total effort	161.0	547.5	650.9	587.1
Rate (%) of non-lethal effort	61.8	100.0	8.4	11.1

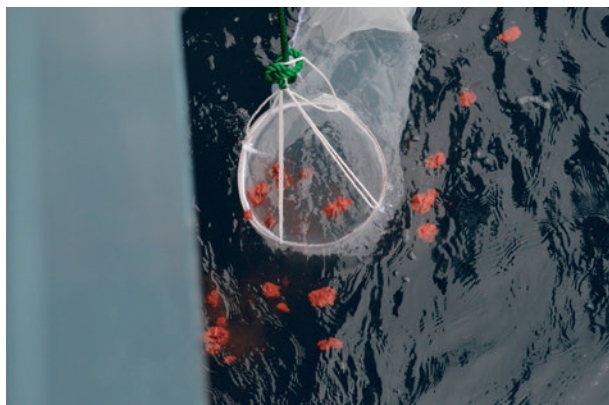

Figure 2. Sampling of sei whale faeces in the 2015 JARPNII offshore survey.

with 100µm mesh size (Figure 2). The sampled faeces were stored using polyethylene bottles at -20°C.

Observation and sampling of whales

Whales were sighted and sampled along the predetermined track-lines. The effort was defined as the time from confirmation of whale species to the time of the shooting.

Analytical procedures

The idea was to compare the results on prey species in the stomach contents (direct observations) and in faeces samples (DNA analyses). As this comparison was not pos-

sible for a same individual, the contents in intestine was used as a proxy for faeces. Therefore prey species in the stomach (direct observation) and intestine (DNA analyses) was compared for a same individual. In addition, prey species in the faeces samples collected were also investigated by DNA analyses.

In the case of genetic analysis, total genomic DNA was extracted using the standard phenol/chloroform extractions protocol of the GENTRA PUREGENE DNA extraction kit (QIAGEN) following the company’s manual. Extracted DNAs were stored in TE buffer. After PCR amplification, the products were analyzed using an Illumina MiSeq (next-generation DNA sequencers) to identify the prey species.

Analysis of stomach content followed standard procedure (Tamura *et al.*, 2016).

RESULTS

Response to question 1

A total of 1,808 experiments were made (1,179 for sei, 393 for Bryde’s and 236 for common minke whales), for 377.2 h (Table 2). Excretion was observed in 38 individuals (30 sei, 6 Bryde’s, and 2 common minke whales). Of these, faeces was obtained successfully from five sei whales. For Bryde’s and common minke whales, faeces could not be obtained due to sinking or spreading of faeces before sampling.

Therefore at the present, the answer to Q1 is ‘yes’ for sei whales and ‘no’ for common minke and Bryde’s whales.

Response to question 2

Table 2 shows that the observation effort and number of excretions observed in the research period. The number of faeces observed is extremely low, 38 cases in 1,808 individual experiments (2.1%) for all surveys and species combined. These percentages were 2.5%, 1.5%, 0.0% and 0.0% for sei, Brydes’s, common minke (offshore) and common minke (coastal), respectively.

These percentages contrast with those of the efficiency of whale (stomach) sampling. For all surveys and species combined there were 297 targeted individuals of which 151 were sampled (50.8%). The percentages by species were 93.6%, 89.3% and 50.8% for sei, Bryde’s and minke (coastal) whales, respectively.

Sampling efficiency of faecal sampling is substantially lower than the whale (stomach) sampling efficiency. Therefore the response to Q2 is ‘no’ for sei, Bryde’s and common minke whales.

Table 2
The results of faecal sampling in the 2014 and 2015 surveys.

Species	Vessel type	Number of experiments (school)	Number of experiments (individuals)	Observation effort (hours)	Observation of excretion (number)	Faecal sampling (number)
2014 JARPNII						
Sei	SSVs	192	346	75.1	11	3
	SVs	134	333	5.9	10	0
Bryde's	SSVs	94	116	25.4	1	0
	SVs	30	42	12.7	2	0
C. minke (Offshore)	SSVs	2	2	0.1	0	0
	SVs	2	2	0.2	0	0
C. minke (Sanriku)	SSVs	49	49	44.8	0	0
C. minke (Kushiro)	SSVs	89	89	60.6	1	0
2015 JARPNII						
Sei	SSVs	193	259	51.6	6	2
	SVs	133	241	7.7	3	0
Bryde's	SSVs	113	147	27.4	2	0
	SVs	70	88	2.4	1	0
C. minke (Offshore)	SSVs	2	2	0.9	0	0
	SVs	0	0	0.0	0	0
C. minke (Sanriku)	SSVs	33	33	31.0	0	0
C. minke (Kushiro)	SSVs	59	59	31.4	1	0
Total						
Sei		652	1,179	140.3	30	5
Bryde's		307	393	67.9	6	0
C. minke (Offshore)		6	6	1.2	0	0
C. minke (Coastal)		230	230	167.8	2	0

Response to question 3

Comparison between direct observation of stomach contents and DNA analysis of intestine

Table 3 shows a comparison of the prey species found in the stomach (direct observation) and in the intestine (DNA analysis) of sei, Bryde's and common minke whales. As indicated earlier, intestine was used as a proxy for faeces.

There is no good correspondence between the preys identified in the stomach and the intestine of the same individuals. In several cases the species could not be identified by the DNA analysis notwithstanding the full stomach of the whales.

A prey of prey species was also observed. For example *Acartia clausii* was identified by the DNA analysis in the individual 14NPCS-M019. This species is known as a major prey of sand lance, which is a known prey species of the common minke whale.

The results of prey identification by the DNA analysis was somewhat different between the upper/middle parts of the small intestine and the large intestine.

DNA analysis of faeces

Table 4 shows the results of the DNA analysis for prey identification from faeces in three sei whales. The DNA analysis could not detect the prey species from the faeces of other three sei whales, which suggest low efficiency of this technique to identify prey species from faeces samples.

Therefore the response to Q3 is 'no' for sei, Bryde's and common minke whales.

Respond to question 4

This question is not addressed in the present study. However whale field surveys are extremely expensive. Funding for some of the surveys involving sampling of whales are provided in part by the sale of by-products.

CONCLUDING REMARKS

Discussions on the feasibility of novel non-lethal techniques in whale research have so far been controversial and inconclusive. This is due a lack of an objective protocol guiding these discussions. The ICR has developed

Table 3
Results of detected prey species in enteral content using next generation DNA sequencers.

Species	ID Number	Prey species observed by stomach contents	Prey species estimated by NGS—Upper part of small intestine	Prey species estimated by NGS—Middle part of small intestine	Prey species estimated by NGS—Large intestine
Sei	14NPSE001	Mackerels (90%) and Japanese anchovy (10%)	Mackerels and Japanese anchovy	Mackerels and Japanese anchovy	No identified
	14NPSE006	Copepods (99%) and krill (1%)	Krill	No identified	Krill
	14NPSE018	Mackerels	Mackerels and Pacific saury	Pacific saury	No identified
	14NPSE044	Japanese sardine (50%), Japanese anchovy (40%) and Mackerels (10%)	Japanese sardine and Japanese anchovy	No identified	No identified
	14NPSE048	Copepods (80%) and Pacific saury (20%)	Pacific saury	Pacific saury	Krill
	14NPSE052	Copepods	Pacific saury	Pacific saury	Pacific saury
	14NPSE067	Copepods	No identified	No identified	No identified
	14NPSE070	Mackerels	Mackerels and Pacific saury	Mackerels	No identified
	Bryde's	14NPB005	Japanese anchovy	Japanese anchovy	Japanese anchovy
14NPB006		Mackerels	Japanese anchovy	No identified	Light fish (<i>Maurolucus muelleri</i>)
14NPB009		Japanese anchovy (90%), Japanese sardine (8%) and Mackerels (2%)	Japanese anchovy	Japanese anchovy	Japanese anchovy, Japanese sardine and krill
14NPB010		Japanese anchovy	Japanese anchovy	No identified	No identified
14NPB016		Japanese anchovy	Japanese anchovy	Japanese anchovy	Krill
14NPB019		Japanese anchovy (99%) and mackerels (1%)	Japanese anchovy	Japanese anchovy	No identified
C.minke		14NPCS-M013	Sand lance	—	—
	14NPCS-M019	Sand lance	—	—	Copepoda (<i>Acartia clausii</i>)
	14NPCS-M021	Sand lance	—	—	No identified
	14NPCK-M013	Japanese sardine	—	—	No identified
	14NPCK-M015	Japanese sardine	—	—	No identified
	14NPCK-M016	Japanese sardine	—	—	Japanese sardine
	14NPCK-M017	Walleye pollock and Japanese sardine	—	—	No identified
	14NPCK-M019	Japanese sardine	—	—	Japanese anchovy
	14NPCK-M027	Walleye pollock and Japanese common squid	—	—	Japanese common squid and krill

NGS: next-generation sequencing.

Table 4

Prey species in faeces of sei whales identified by the NGS.

Species	ID Number	Results
Sei	140527SEI	<i>Copepoda (Oithona similis)</i>
Sei	140528SEI	<i>Copepoda (Oithona similis)</i>
Sei	150529SEI	Euphausiacea, Calanoida

a protocol with four questions that should be responded to in order to evaluate the feasibility of novel non-lethal techniques. An objective evaluation of the available data in the context of the four questions will make possible more useful discussions and conclusions on the feasibility of a given novel non-lethal technique. In this study the protocol was used to evaluate the feasibility of the analysis of whale faeces in studies on feeding ecology specifically to respond to questions on prey consumption and prey preferences. Results of the evaluation following the protocol suggest that at this stage of knowledge, such technique is not feasible and therefore cannot replace the analysis of stomach content to respond the same questions.

ACKNOWLEDGEMENTS

The author would like to thank all captains, crews and researchers, who were involved in the JARPNII surveys.

REFERENCES

Bando, T., Isoda, T., Nakai, K., Sato, H., Okitsu, Y., Tsunekawa, M., Fujii, K., Yamasaki, M., Honma, H. and Eguchi, K. 2016. Cruise Report of the Second Phase of the Japanese Whale Research Program under Special Permit in the Western North Pacific (JARPNII) in 2015 (part I)—Offshore component—. Paper SC/66b/SP2 presented to the IWC Scientific Committee, May 2016 (unpublished). 14 pp. [Available from the IWC

Secretariat].

International Whaling Commission. 2016. Report of the Expert Panel of the final review on the western North Pacific Japanese Special Permit Programme (JARPNII). Paper SC/66b/Rep06 presented to the IWC Scientific Committee, June 2016 (unpublished). 96 pp. [Available from the IWC Secretariat].

Isoda, T., Kawabe, S., Ohkoshi, C., Mogoe, T. and Matsuoka, K. 2016. Results of the NEWREP-A dedicated sighting survey in Area IV during the 2015/16 austral summer season. Paper SC/66B/IA5 presented to the IWC Scientific Committee, June 2016 (unpublished). 25 pp. [Available from the IWC Secretariat].

Kishiro, T., Yoshida, H., Ito, N., Mogoe, T., Nakamura, G., Maeda, H., Miyakawa, N., Hirose, A., Ota, M., Kato, K., Hayashi, R., Yoshii, K., Kim, Y., Miyashita, T., Kumagai, S., Sato, H., Kimura, Y., Hiruda, H., Katsumata, T., Nakai, K. and Kato, H. 2016. Cruise Report of the Second Phase of the Japanese Whale Research Program under Special Permit in the western North Pacific (JARPNII) in 2015 (Part III)—Coastal component off Kushiro. Paper SC/66b/SP3 presented to the IWC Scientific Committee, June 2016 (unpublished). 12 pp. [Available from the IWC Secretariat].

Mogoe, T., Tamura, T., Yoshida, H., Kishiro, T., Yasunaga, G., Bando, T., Konishi, K., Nakai, K., Kanda, N., Kitamura, T., Nakano, K., Katsumata, H., Handa, Y. and Kato, H. 2015. Preliminary report of efficiency and practicability of biopsy sampling, faecal sampling and prey species identification from genetic analyses in 2014, and work plan for non-lethal research in JARPNII. Paper SC/66a/SP11 presented to the IWC Scientific Committee, May 2015 (unpublished). 11 pp. [Available from the IWC Secretariat].

Tamura, T., Konishi, K. and Isoda, T. 2016. Updated estimation of prey consumption by common minke, Bryde’s and sei whales in the western North Pacific. Paper SC/F16/JR15 presented to the Expert Panel of the Final Review on the western North Pacific Japanese Special Permit programme (JARPNII), Tokyo, February 2016 (unpublished). 58 pp. [Available from the IWC Secretariat].

Technical Report (not peer reviewed)

Results of feasibility studies on novel non-lethal techniques to address the main objectives of NEWREP-A

Mutsuo GOTO* and Satoko INOUE

Institute of Cetacean Research, 4–5 Toyomi-cho, Chuo-ku, Tokyo 104–0055, Japan

*Contact e-mail: goto@cetacean.jp

ABSTRACT

This paper presents the progress made in the research conducted to evaluate the feasibility of some novel non-lethal techniques. The techniques are DNA methylation for age determination and progesterone analysis for determining the reproductive status of whales. Age and reproductive status of whales are key information for addressing one of the main objectives of the NEWREP-A. Potentially both techniques can be used on biopsy samples collected from free ranging whales. Regarding the former technique, effort was spent to investigate differences in methylation rates between Antarctic minke and humpback whales. Regarding the latter technique, effort was made to examine progesterone from blubber of female Antarctic minke whales for which high qualitative reproductive data was already available. A final evaluation of both techniques will be made in the near future considering the protocol developed for evaluating novel non-lethal techniques (Mogoe, this issue).

INTRODUCTION

The Institute of Cetacean Research (ICR) conducts whale research using both lethal and non-lethal techniques. Lethal techniques are required for key research objectives of NEWREP-A such as the estimation of biological parameters based on age and reproductive data, and feeding ecology based on qualitative and quantitative analyses of stomach contents.

Routine non-lethal techniques used by ICR include systematic sighting surveys for abundance estimates, oceanographic surveys for ecological studies and photo-id and biopsy sampling for studies on movement, distribution and stock structure in blue, humpback and right whales. These routine non-lethal techniques have been used by ICR for many years in its whale research programs in the Antarctic and western North Pacific.

More recently some novel non-lethal techniques have been proposed, which potentially could be used to address some key objectives of NEWREP-A. For example, DNA methylation in skin to investigate the age of the animals, analysis of progesterone level in blubber to investigate the reproductive status of female whales, and stable isotopes in skin/blubber to study the feeding ecology of whales. These techniques can potentially be used with skin/blubber samples obtained by biopsy sampling.

ICR started the evaluation of the feasibility of using the

non-lethal techniques mentioned above. The evaluation involves two aspects, the first is whether biopsy sampling (source of the samples) is feasible in the target species of the research programs. The other aspect is the analytical one, which involves laboratory and statistical analyses (see Mogoe, this issue).

The degree of difficulty of biopsy sampling is different among whale species, being more difficult for smaller and fast swimming species such as the minke whale. Biopsy sampling was considered feasible in the case of large whales such as sei and Bryde's whales in the North Pacific however it was considered not feasible for the case of North Pacific common and Antarctic minke whales (Yasunaga *et al.*, 2017; 2018).

This paper summarizes the laboratory and statistical procedures to investigate the feasibility of using non-lethal techniques to determine age and reproductive status in Antarctic minke whale, the target species for lethal sampling under the NEWREP-A. Tissue samples from the sampled Antarctic minke whale individuals were used as a proxy for biopsy sampling of skin and blubber. The outputs of these studies will be used for a final evaluation of non-lethal techniques based on some specified criteria (see Mogoe, this issue).

DNA METHYLATION FOR AGE DETERMINATION IN WHALES

DNA methylation as a tool for age determination

Chronological age is an important factor in animal ecology because many biological characteristics change with time (Jarman *et al.*, 2015). Biological ageing is a combination of programmed processes (Berdasco and Esteller, 2012; Horvath, 2013) and accumulated changes caused by unrepaired environmental damage (Kujoth *et al.*, 2005). Recent evidence suggests that epigenetic changes are both directing the process of ageing and being caused by it (Maegawa *et al.*, 2010; Koch *et al.*, 2011; Winnefeld and Lyko, 2012; Hannum *et al.*, 2013; Horvath, 2013).

The best studied class of epigenetic change in vertebrates is the methyl group presence or absence at the C5 position of Cytosine residues that are adjacent to Guanidine residues ('CpG sites') (Figure 1). CpG methylation levels play an important role in control of gene expression, where higher methylation levels ('hypermethylation') generally reduce gene transcription rate.

Methylation changes at specific CpGs have been linked to age in mice (Maegawa *et al.*, 2010) and humans (Christensen *et al.*, 2009; Grönniger *et al.*, 2010; Bocklandt *et al.*, 2011; Koch and Wagner, 2011; Hannum *et al.*, 2013). For the cetacean species, the DNA methylation approach was recently developed and applied to humpback whales with the aim of age determination in this species (Polanowski *et al.*, 2014).

Detection methods

DNA methylation can be detected by several methods, one of them being the pyrosequencing of bisulfite treat-

ed DNA, which was used in the case of the humpback whale (Polanowski *et al.*, 2014) and in the present study for Antarctic minke whales. This method implies the use of bisulfite treatment of DNA to determine its pattern of methylation. In animals it predominantly involves the addition of a methyl group to the carbon-5 position of cytosine residues of the dinucleotide CpG, and is implicated in repression of transcriptional activity. Treatment of DNA with bisulfite converts cytosine residues to uracil, but leaves 5-methylcytosine residues unaffected. Therefore, DNA that has been treated with bisulfite retains only methylated cytosines. The percentage of DNA mismatch is recorded, this gives the user a percentage methylation per CpG site.

Research on DNA methylation at ICR

As a first step to evaluate the DNA methylation for age determination purpose, the same method used for humpback whale was applied to Antarctic minke whale. The purpose in this first step was to compare DNA methylation rates between two baleen whale species. The work conducted on Antarctic minke whale is explained in the sections below.

Samples

A total of 100 Antarctic minke whale samples taken during the JARPAII were used for the study. Each sample had good age information obtained by earplug reading. Details of the samples are shown in Table 1. DNA was extracted from each sample using standard protocols.

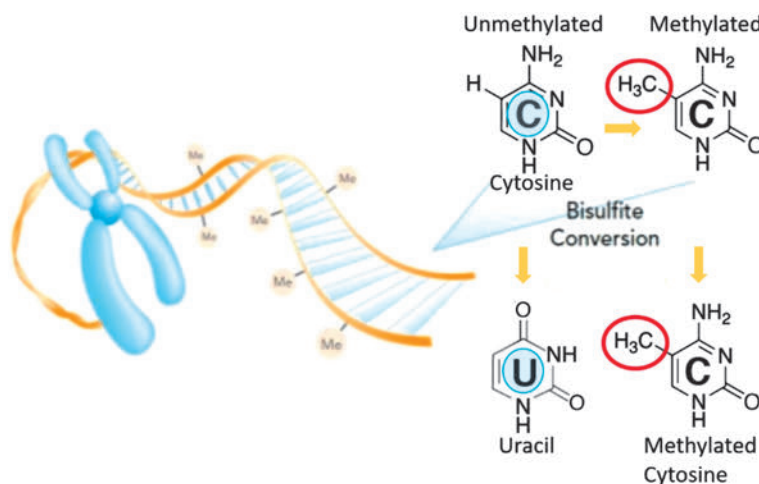

Figure 1. Methylation of cytosine to form 5-methylcytosine occurs at the same C5 position on the pyrimidine ring (upper right), the same position distinguishes thymine from the analogous RNA base uracil after bisulfite conversion (lower right), and then methylation rate is estimated by the ratio of thymine and cytosine.

Table 1

The sample sizes of Antarctic minke whales used for DNA methylation analysis by pyrosequencing method by sampling season, sex and age classes.

Season	Sex	Age					Total
		-10	11-20	21-30	31-40	41-	
2010/2011	F	10	16	9	3	3	41
	M	7	8	8	2		25
2011/2012	F	1	8	11	6	1	27
	M	1	3	1	1	1	7
Total		19	35	29	12	5	100



Figure 2. PYROMARK 24 Pyrosequencing System used in this study.

Identification of age-related epigenetic markers in Antarctic minke whale

The procedure for identification of age-related DNA methylation sites and measurement of methylation levels followed Polanowski *et al.* (2014). The following seven CpG sites in three genes were selected for this study because they showed significant correspondence between CpG methylation levels and age in humpback whales.

Gene TET2 (three sites: CpG+16; CpG+21 and CpG+31)

Gene CDKN2A (three sites: CpG+297; CpG+303 and CpG+309)

Gene GRIA2 (one site: CpG+202)

Measurement of cytosine methylation levels and correlation with age

Cytosine methylation levels were measured with Qiagen PyroMark assays. The pyrosequencing assays were designed using PYROMARK Assay Design Software (Version 2.0.1, Qiagen). Pyrosequencing was performed on a PYROMARK 24 Pyrosequencing System (Qiagen) (Figure 2). The PYROMARK Q24 software gave percentage methylation values for each CpG site (Figure 3).

DNA methylation rates in the seven sites were scored successfully, and regressions of each CpG methylation rate against age determined by earplug reading were made (Figure 4).

Correlations of all seven CpG sites in three loci with age based on earplug reading were lower than in the case of the humpback whale study (Table 2). The standard deviation for Antarctic minke whale by the Leave One

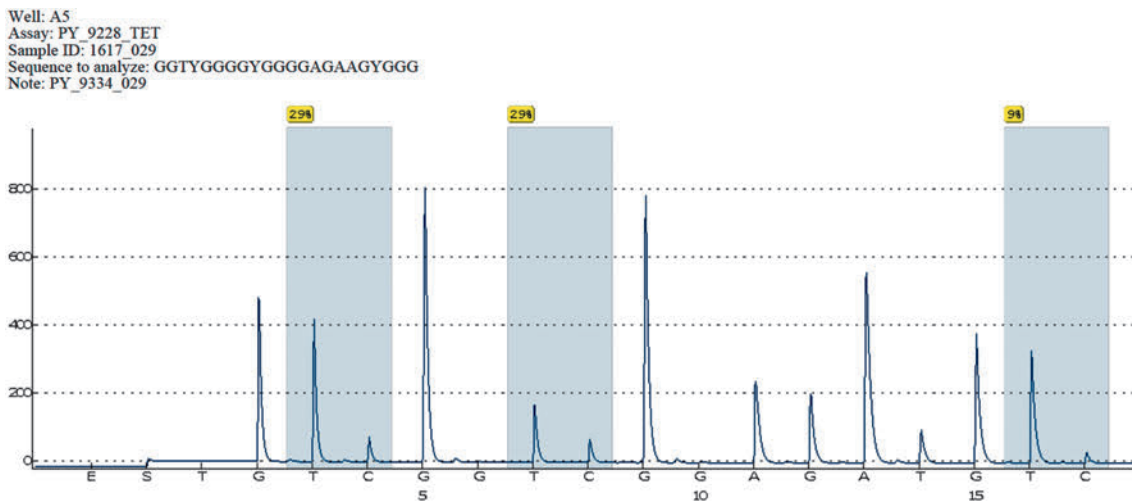

Figure 3. An Example of output of CpG Pyrogram report by PYROMARK 24 Pyrosequencing System of three CpG sites in TET2 gene. Methylation rate of each CpG site is estimated by the ratio of the integral of Thymine to Cytosine in gray shadow.

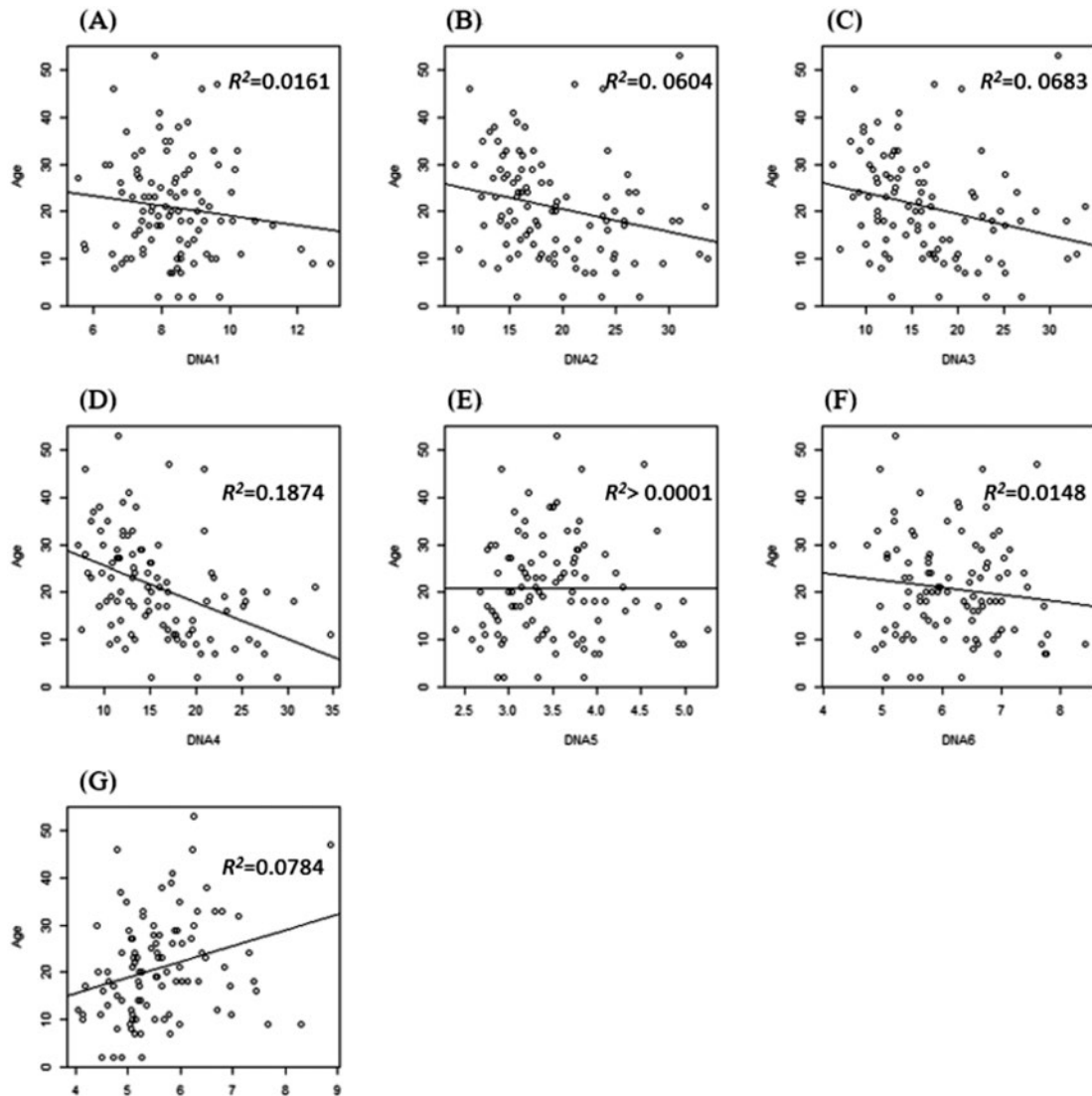

Figure 4. Regressions between CpG methylation and age determined by earplug at seven sites ($n=100$). CpG sites are: (A) GRIA2_CpG+202, (B) TET2_CpG+16, (C) TET2_CpG+21, (D) TET2_CpG+31, (E) CDKN2A_CpG+297, (F) CDKN2A_CpG+303 and (G) CDKN2A_CpG+309.

Table 2

Comparison of the coefficient of determination (R^2) between methylation rates of seven CpG sites and age determined from earplug reading in humpback (Polanowski *et al.*, 2014) and Antarctic minke (this study) whales.

Gene and CpG position	Humpback whale	This study
GRIA2_CpG+202	0.469	0.0161
TET2_CpG+16	0.174	0.0604
TET2_CpG+21	0.189	0.0683
TET2_CpG+31	0.409	0.1874
CDKN2A_CpG+297	0.409	>0.0001
CDKN2A_CpG+303	0.211	0.0148
CDKN2A_CpG+309	0.344	0.0784

Out Cross Validation (LOOCV) method was estimated at 8.865 years (Goto *et al.*, 2018), while that for the humpback whale was estimated at 2.991 years using the same method (Polanowski *et al.*, 2014). Therefore the main conclusion of this study is that the methylation rates for a same gene and sites are different between the two baleen whale species.

Future works

The ICR is planning investigation of additional informative methylation sites. Such investigation should include analyses on how the methylation rates changes among body tissues as well among body parts of the whale, among other factors.

With all information at hand the feasibility of using the DNA methylation technique for age determination in Ant-

arctic minke whale can be further evaluated.

HORMONE ANALYSIS FOR DETERMINATION OF REPRODUCTIVE STATUS IN WHALES

Progesterone analysis for determination of reproductive status in female whales

In cetacean species female reproductive status has been determined by direct observation of reproductive organs such as ovaries and uteruses. Progesterone is one of the sex hormones produced from ovaries and placenta (when an individual gets pregnant) and it has role in ovulation and maintaining pregnancy.

Previous studies suggested that an elevation in the concentration of progesterone in serum can be indicative of ovulation and pregnancy diagnosis in captive cetaceans (Sawyer-Steffan *et al.*, 1983; Schroeder and Keller, 1990; Kirby, 1990). Recently, the relationship between progesterone and reproductive status has been studied based on samples which potentially can be obtained by non-lethal approach from free ranging cetaceans (Table 3). Several of those studies reported that progesterone can be detected from the samples used, and that its concentration was substantially higher in pregnant than immature females.

Methods

There are two main groups of methods to measure progesterone level, one is liquid chromatography (e.g. HPLC and LC-MS in Table 3) and the other is immunoassay. The latter has been used in the studies conducted by the ICR.

Immunoassay

Immunoassay is a method that measures the presence or concentration of target analytes (like hormones) in solution using antigen-antibody reactions. The antigen-antibody reaction is a specific binding between an anti-

gen and an antibody. The reaction can be used for the detection of antigens or antibodies specific for analytes.

Immunoassay measures the formation of antigen-antibody complexes by labeling or labeling-free format. There are several types of immunoassays depending on labeling material, for example, labeling by radioisotope is called radioimmunoassay (RIA), labeling by enzyme is called enzyme immunoassay (EIA) or enzyme-linked immunosorbent assay (ELISA). The immunoassay used at the ICR is the latter one (ELISA) (Figure 5).

Research on progesterone at ICR

In the ICR, the relationship between concentration of progesterone in blubber and reproductive status in the Antarctic minke whale was investigated by examining female Antarctic minke whales. The main question was whether or not progesterone concentration in blubber can be used as an indicator of the reproductive status of female whales.

Samples

Antarctic minke whales used in this study were collected between December 2015 and February 2016 by NEWREP-A in the Pacific sector of the Antarctic Ocean. Whales were sampled randomly from a predetermined zigzag track line designed to cover the whole research area. A total of 333 Antarctic minke whales (103 males and 230 females) were sampled during the survey. All sampled females (230) were used in this study. The blubber tissues were obtained from the lateral side of each whale by researchers on board the research base ship. The tissues were stored at -20°C until analyses at the laboratory.

Determination of reproductive status

Reproductive status was determined by standard procedures (Lockyer 1984; 1987). The sexual maturity of

Table 3
Summary of the non-lethal studies to measure sex hormones in whales.

Species	Samples	Methods	References
<i>Mysticeti</i>			
Blue whale <i>Balaenoptera musculus</i>	Feces	RIA, HPLC	Valenzuela-Molina <i>et al.</i> (2018)
North Atlantic right whale <i>Eubalaena glacialis</i>	Feces	RIA	Corkeron <i>et al.</i> (2017)
	Blow	LC-MS	Hogg <i>et al.</i> (2009)
Humpback whale <i>Megaptera novaeangliae</i>	Blubber	EIA	Clark <i>et al.</i> (2016)
	Blubber	EIA	Pallin <i>et al.</i> (2018)
	Blow	LC-MS	Hogg <i>et al.</i> (2009)
<i>Odontoceti</i>			
Beluga <i>Delphinapterus leucas</i>	Blow	ELISA	Richard <i>et al.</i> (2017)

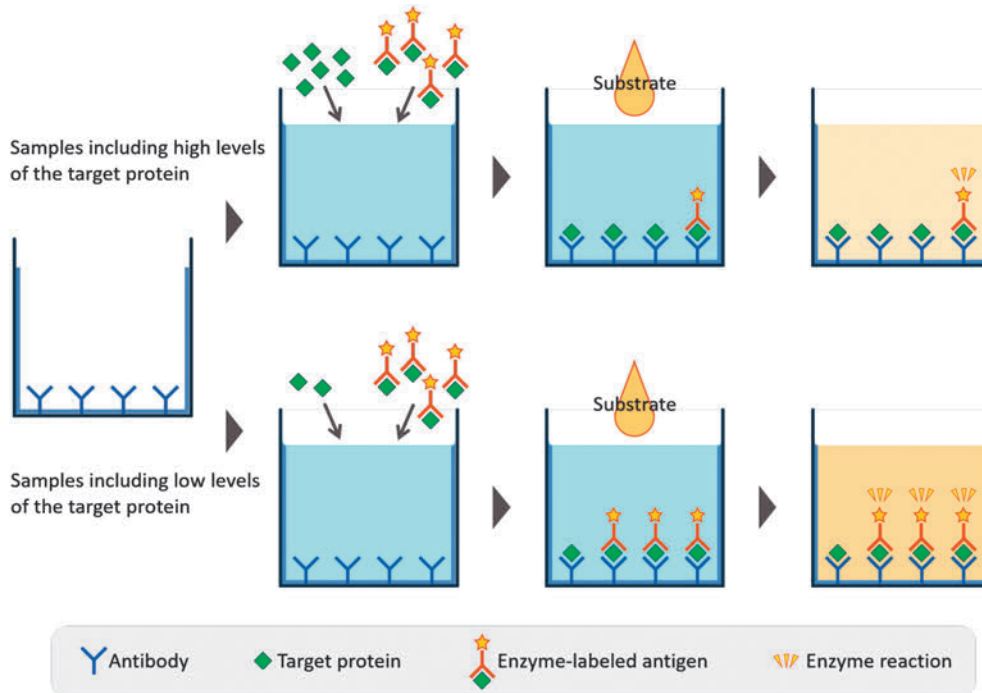

Figure 5. Schematic representation of ELISA. An antibody specific for a target protein is immobilized on the surface of microplate wells. Then it is incubated with samples containing the target protein and a known amount of enzyme-labeled target protein. After the reaction, the substrate is added and the activity of the microplate well-bound enzyme is measured. When the antigen level in the sample is high, the level of antibody-bound enzyme-labeled antigen is lower and the color is lighter. Conversely, when it is low, the level of antibody-bound enzyme-labeled antigen is higher and the color is darker.

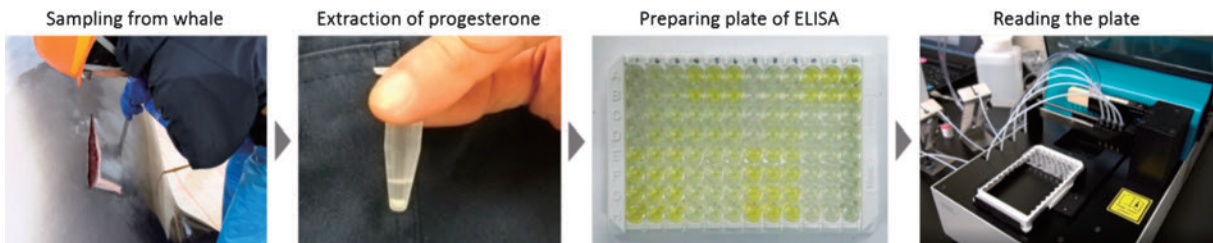

Figure 6. Flow from collection of blubber sample to measurement of progesterone concentration.

females was determined by the presence of at least one corpus luteum or corpus albicans in either ovary. In the case where no corpus luteum and corpus albicans was observed, the female was categorized as immature. Reproductive status of mature female whales was classified into three categories (resting, ovulating and pregnant), based upon observation of the ovary and uterus.

Extraction and measurement of progesterone

The procedures for progesterone extraction and defatting treatment were performed according to Kellar *et al.* (2013) and Nagata *et al.* (1996), respectively. Progesterone concentrations were determined by a commercially available ELISA kit, using the Crocodile Mini Workstation (Titertek Berthold, Germany). All samples were processed and quantified in triplicate. Figure 6 shows the

steps followed in the progesterone concentration study.

Results

Table 4 shows the results of the reproductive status determined by direct observation of reproductive organs, progesterone concentrations by reproductive status and other biological data for the total sample of 230 female whales.

Seventy-six percent of the samples were mature females, and 90% of the mature females were pregnant. About 73% of the immature whales were below the detection limit of the assay for progesterone concentration (0.2 ng/g). The pregnant females had the highest median of 72 ng/g (range: 13–740 ng/g), with wider concentrations of progesterone. All pairwise comparisons apart from the ovulating-pregnant comparison, resulted in

Table 4

Biological data, determined reproductive status and progesterone concentration in the female Antarctic minke whales.

	Immature	Resting	Ovulating	Pregnant
<i>Body length (m)</i>				
Median	7.37	8.81	9.01	8.78
Range	5.17–8.51	7.65–9.32	8.45–9.40	7.71–10.06
<i>Ovary</i>				
total CL				
Mean	0	0	1	1
Range	0	0	1–1	1–2
total CA				
Mean	0	18	16	13
Range	0	1–44	0–45	0–40
<i>Progesterone Concentration (ng/g)</i>				
Median	<0.2	15	26	72
Range	<0.2–2.6	<0.2–34	24–150	13–740
N	56	11	6	157

significant statistical differences (Steel-Dwass post-hoc test, $p < 0.05$). However, overlap of progesterone concentrations was observed between each reproductive status with the exception of the cases immature/ovulating and immature/pregnant.

Summary

In this study, significant differences were found in median progesterone concentration between all reproductive categories except in the case between ovulating and pregnant females. However, the ranges of progesterone concentration overlapped between each reproductive category with the exception of the cases immature/ovulating and immature/pregnant. The results of this study indicated that the progesterone concentration in blubber, which potentially can be obtained by biopsy sampling, cannot be used as an accurate diagnostic index to determine the reproductive status in the Antarctic minke whale.

CONCLUDING REMARKS

Progress has been made in the work to evaluate novel non-genetic techniques that potentially could be used to address some important objectives of NEWREP-A. The degree of progress is different among the specific technique examined and obviously further refinement work is required. Stable isotopes are also being examined to elucidate the feeding habits of some large baleen whale species in the Antarctic. As stated earlier a final evaluation of the feasibility of those techniques will be made in the near future following specific criteria (see Mogoe,

this issue).

ACKNOWLEDGEMENTS

We thank crew members and researchers that participated in the 2010/11 and 2011/12 JARPAII, 2015/16 and 2016/17 NEWREP-A surveys in Antarctic for collecting data and samples of the Antarctic minke whale used in this study. We thank Natsumi Endo (Tokyo University of Agriculture and Technology) for providing ELISA assay.

REFERENCES

- Berdasco, M. and Esteller, M. 2012. Hot topics in epigenetic mechanisms of aging. *Aging Cell* 11: 181–186.
- Bocklandt, S., Lin, W., Sehl, M.E., Sanchez, F.J., Sinsheimer, J.S., Horvath, S. and Vilain, E. 2011. Epigenetic predictor of age. *PLoS ONE* 6: e14821.
- Christensen, B.C., Houseman, E.A., Marsit, C.J., Zheng, S., Wrensch, M.R., Wiemels, J.L., Nelson, H.H., Karagas, M.R., Padbury, J.F. and Bueno, R. 2009. Aging and environmental exposures alter tissue-specific DNA methylation dependent upon CpG Island context. *PLoS Genetics* 5: e1000602.
- Clark, C.T., Fleming, A.H., Calambokidis, J., Kellar, N.M., Allen, C.D., Catelani, K.N., Robbins, M., Beaulieu, N.E., Steel, D. and Harvey, J.T. 2016. Heavy with child? Pregnancy status and stable isotope ratios as determined from biopsies of humpback whales. *Conserv. Physiol.* 4 (1): 1–13.
- Corkeron, P., Rolland, R.M., Hunt, K.E. and Kraus, S.D. 2017. A right whale pootree: classification trees of faecal hormones identify reproductive states in North Atlantic right whales (*Eubalaena glacialis*). *Conserv. Physiol.* 5 (1): cox006.
- Goto, M., Kitakado, T., Taguchi, M. and Pastene, L.A. 2018. Feasibility of the DNA methylation technique for age determination in the Antarctic minke whale. Paper SC/67b/SDDNA04 presented to the IWC Scientific Committee, May 2018 (unpublished). 8 pp. [Available from the IWC Secretariat].
- Grönniger, E., Weber, B., Heil, O., Peters, N., Stäb, F., Wenck, H., Korn, B., Winnefeld, M. and Lyko, F. 2010. Aging and chronic sun exposure cause distinct epigenetic changes in human skin. *PLoS Genetics* 6: e1000971.
- Hannum, G., Guinney, J., Zhao, L., Zhang, L., Hughes, G., Sada, S.V., Klotzle, B., Bibikova, M., Fan, J.B., Gao, Y., Deconde, R., Chen, M., Rajapakse, I., Friend, S., Ideker, T. and Zhang, K. 2013. Genome-wide methylation profiles reveal quantitative views of human aging rates. *Molecular Cell* 49: 359–367.
- Hogg, C.J., Rogers, T.L., Shorter, A., Barton, K., Miller, P.J.O. and Nowacek, D. 2009. Determination of steroid hormones in whale blow: it is possible. *Mar. Mamm. Sci.* 25 (3): 605–618.
- Horvath, S. 2013. DNA methylation age of human tissues and cell types. *Genome Biology* 14: R115.
- Jarman, S.N., Polanowski, A.M., Faux, C.E., Robbins, J., De Paoli-Iseppi, R., Bravington, M. and Deagle, B.E. 2015. Molecular biomarkers for chronological age in animal ecol-

- ogy. *Mol. Ecol.* 24: 4826–4847.
- Kellar, N.M., Keliher, J., Trego, M.L., Catelani, K.N., Hanns, C., George, J.C.C. and Rosa, C. 2013. Variation of bowhead whale progesterone concentrations across demographic groups and sample matrices. *Endang. Species Res.* 22: 61–72.
- Kirby, V.L. 1990. Endocrinology of marine mammals. pp. 303–351. In: L.A. Dierauf (ed.) *Handbook of marine mammal medicine: health, diseases, and rehabilitation*. CRC Press, Boston, 735 pp.
- Koch, C.M. and Wagner, W. 2011. Epigenetic-aging-signature to determine age in different tissues. *Aging* 3: 1018.
- Koch, C.M., Suschek, C.V., Lin, Q., Bork, S., Goergens, M., Jousen, S., Pallua, N., Ho, A.D., Zenke, M. and Wagner, W. 2011. Specific age-associated DNA methylation changes in human dermal fibroblasts. *PLoS ONE* 6: e16679.
- Kujoth, G.C., Hiona, A., Pugh, T.D., Someya, S., Panzer, K., Wohlgemuth, S.E., Hofer, T., Seo, A.Y., Sullivan, R., Jobling, W.A., Morrow, J.D., Van Remmen, H., Sedivy, J.M., Yamasoba, T., Tanokura, M., Weindruch, R., Leeuwenburgh, C. and Prolla, T.A. 2005. Mitochondrial DNA mutations, oxidative stress, and apoptosis in mammalian aging. *Science* 309: 481–484.
- Lockyer, C. 1984. Review of baleen whale (Mysticeti) reproduction and implications for management. *Rep. int. Whal. Commn* (Special Issue) 6: 27–50.
- Lockyer, C. 1987. Observations on the ovary of the southern minke whale. *Sci. Rep. Whales Res. Inst.* 38: 75–89.
- Maegawa, S., Hinkal, G., Kim, H.S., Shen, L., Zhang, L., Zhang, J., Zhang, N., Liang, S., Donehower, L.A. and Issa, J-P.J. 2010. Widespread and tissue specific age-related DNA methylation changes in mice. *Genome Research* 20: 332–340.
- Nagata, S., Kondou, M., Kaneko, H., Araki, K., Nambo, Y., Oikawa, M., Watanabe, G. and Taya, K. 1996. A simple defatting method using a partition method of acetonitrile and n-hexan for radioimmunoassay of low blood levels of estradiol-17 β . *J Reprod Dev* 42: j43–j49 (in Japanese with English abstract).
- Pallin, L., Robbins, J., Kellar, N., Bérubé, M. and Friedlaender, A. 2018. Validation of a blubber-based endocrine pregnancy test for humpback whales. *Conserv. Physiol.* 6 (1): coy031.
- Polanowski, A.M., Robbins, J., Chandler, D. and Jarman, S.N. 2014. Epigenetic estimation of age in humpback whales. *Mol. Ecol. Resour.* 14 (5): 976–987.
- Richard, J.T., Robeck, T.R., Osborn, S.D., Naples, L., McDermott, A., LaForge, R., Romano, T.A. and Sartini, B.L. 2017. Testosterone and progesterone concentrations in blow samples are biologically relevant in beluga (*Delphinapterus leucas*). *Gen. Comp. Endocrinol.* 246: 183–193.
- Sawyer-Steffan, J.E., Kirby, V.L. and Gilmartin, W.G. 1983. Progesterone and estrogens in the pregnant and nonpregnant dolphin, *Tursiops truncatus*, and the effects of induced ovulation. *Biol. Reprod.* 28 (4): 897–901.
- Schroeder, J.P. and Keller, K.V. 1990. Artificial insemination of bottlenose dolphins. pp. 447–460. In: S. Leatherwood and R.R. Reeves (eds.) *The bottlenose dolphin*. Academic Press, San Diego, 653 pp.
- Valenzuela-Molina, M., Atkinson, S., Mashburn, K., Gendron, D. and Brownell, R.L.Jr. 2018. Fecal steroid hormones reveal reproductive state in female blue whales sampled in the Gulf of California, Mexico. *Gen. Comp. Endocrinol.* 261: 127–135.
- Winnefeld, M. and Lyko, F. 2012. The aging epigenome: DNA methylation from the cradle to the grave. *Genome Biology* 13: 165.
- Yasunaga, G., Inoue, S., Yoshida, H. and Kitakado, T. 2017. Update of analyses on efficiency of biopsy sampling for sei, Bryde's and common minke whales, based on data and samples obtained during the 2014–2016 JARPNII surveys. Paper SC/67a/SCSP11 presented to the IWC Scientific Committee. May 2017 (unpublished). 9 pp. [Available from the IWC Secretariat].
- Yasunaga, G., Konishi, K., Isoda, T. and Tamura, T. 2018. Results of the feasibility study on biopsy sampling and satellite tagging of Antarctic minke whales under NEWREP-A. Paper SC/67B/SCSP04 presented to the IWC Scientific Committee, May 2018 (unpublished). 8 pp. [Available from the IWC Secretariat].

Technical Report (not peer reviewed)

Using JARPA and JARPAIL platforms for investigating the occurrence of marine debris in the Indo-Pacific region of the Antarctic

Tatsuya ISODA*, Tsutomu TAMURA and Luis A. PASTENE

Institute of Cetacean Research, 4–5 Toyomi-cho, Chuo-ku, Tokyo 104–0055, Japan

*Contact e-mail: isoda@cetacean.jp

ABSTRACT

Records of marine debris and entanglements of whales in Antarctic waters are very limited. In this study, the information on marine debris and entanglements collected during JARPA/JARPAIL and Japanese dedicated whale sighting surveys in the period 1987/88–2014/15, is summarized. The surveys were conducted in the Indo-Pacific sector, south of 60°S. Marine debris on the sea surface was recorded during systematic sighting surveys. A total of 163 pieces were found with buoys/floats being the most abundant (69% of all marine debris recorded). The highest density index (DI: number of marine debris observed per 100 n.miles) was recorded in Areas IV (70°E–130°E) and V (130°E–170°W) (DI: 0.15). The stomachs of 10,660 Antarctic minke whales, 16 dwarf minke whales and 17 fin whales caught under JARPA/JARPAIL were also examined for the presence of debris. A total of 71 pieces were found in the stomachs of the three species. The number of plastic debris per 100 Antarctic minke whales was estimated at 0.08. Four cases of entanglement in a total of 10,660 Antarctic minke whales examined, were found. Given these low indices, the negative effects of marine debris on whales in the Antarctic is expected to be limited at present.

INTRODUCTION

The Antarctic is one of the most isolated places on earth, and the effects of human activities in this area is limited. However in recent years marine debris has been recorded in sub-Antarctic and Antarctic islands, but the information is limited (Barnes *et al.*, 2010; Ivar do Sul *et al.*, 2011).

JARPA/JARPAIL conducted systematic monitoring of the Antarctic ecosystem for a long period of time, which included observation of marine debris in whales and their environment. The present study summarizes the observations on marine debris collected by JARPA/JARPAIL and Japanese dedicated whale sighting surveys in the Indo-Pacific region of the Antarctic, over a period of more than 20 years. The relevance of this kind of survey is that marine debris could affect whales through ingestion and entanglements.

MATERIALS AND METHODS

Surveys

JARPA was conducted during the austral summer seasons (December–March) from 1987/88 to 2004/05 seasons, while JARPAIL was conducted from 2005/06 to 2013/14. These long-term programs included sighting surveys and oceanographic surveys for management and monitoring

purposes concurrently with whale sampling to study biological parameters (GOJ, 2005).

The present study on marine debris and entanglements was based on data collected by the JARPA/JARPAIL and by a Japanese dedicated whale sighting survey conducted in the 2014/15 season. Details of the general methodology and survey procedures can be found in Nishiwaki *et al.* (2006) and Nishiwaki *et al.* (2014).

Research area

The research area comprised the Indo-Pacific region of the Antarctic, specifically the International Whaling Commission (IWC) Antarctic management Areas III (East) (35°E–70°E), IV (70°E–130°E), V (130°E–170°W) and VI (West) (170°W–145°W), south of 60°S.

Observation of marine debris on the sea surface

Marine debris (macro debris) observations on the sea surface were made from dedicated sighting vessels (Figures 1 and 2).

For each debris found, sighting date, sighting position and types of marine debris were recorded. Marine debris data was roughly sorted into three types of debris: metal, petrochemical products and others. The density index (DI: number of marine debris per 100 n.miles) was also



Figure 1. Sighting vessel from where the observations were made (left) and sighting activity of whale schools and marine debris (right).



Figure 2. Example of marine debris found on the sea surface. The buoy was observed at 67°S; 179°W during the 2013/14 season.

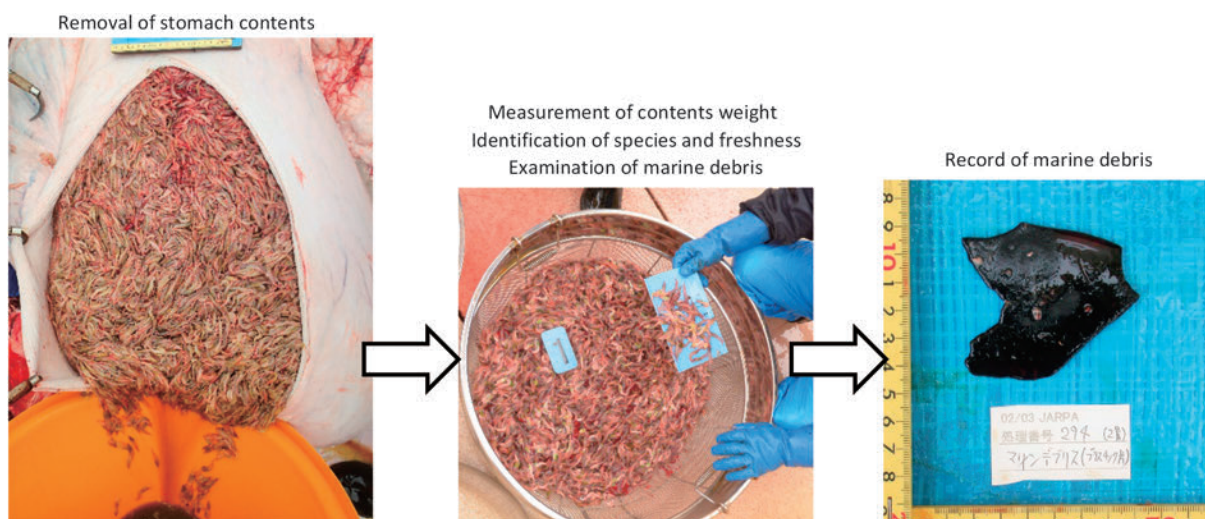

Figure 3. Examination of marine debris in whale stomachs onboard the research base vessel.

calculated in the period 1995/96–2014/15. No independent sighting surveys were conducted in the 2010/11, 2011/12 and 2013/14 seasons due to external interferences.

Observation of marine debris in whale's stomach

The stomachs of 10,660 Antarctic minke whales (*Balaenoptera bonaerensis*), 16 dwarf minke whales (*B. acutorostrata* subsp.) and 17 fin whales (*B. physalus*) were examined for the occurrence of debris.

The examination of whale stomachs was conducted onboard the research base vessel as shown in Figure 3. The three stomach chambers and the duodenal ampulla

were examined macroscopically during the JARPA. Only the fore and main stomachs were examined during the JARPAII. Marine debris and objects other than preys were tabulated by five categories: feather, stone, wood, plastic and other. The sizes of solid objects (stone, wood and plastic) were estimated from photographic records.

The relationship between body length and body weight of Antarctic minke whales was compared between whales with and without debris in their stomachs ($n=8,705$). This was made to examine the body condition of the whales with debris in their stomachs.

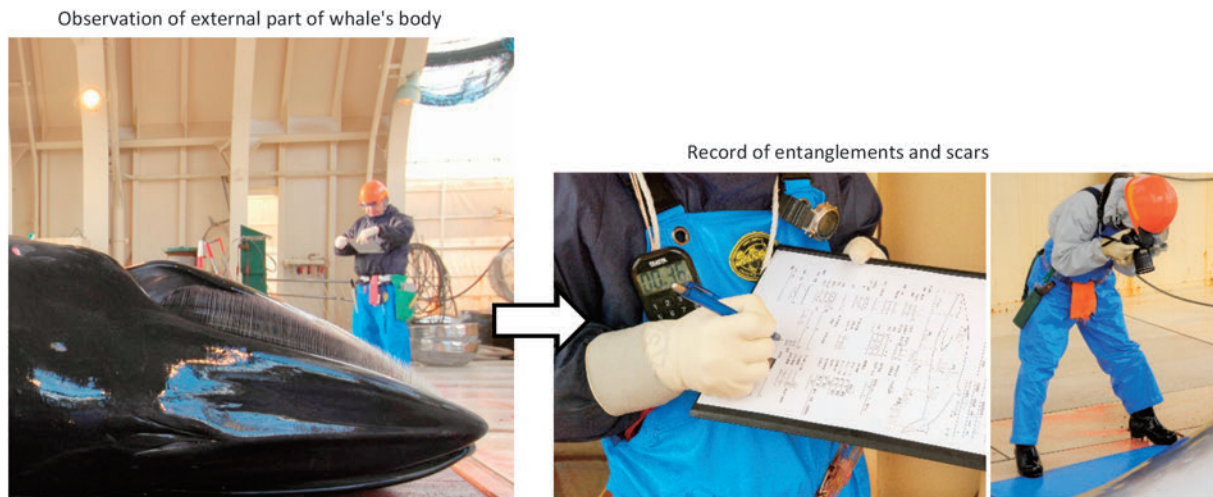

Figure 4. Observation of entanglements onboard the research base vessel.

Table 1

Summary of the sightings of marine debris on the sea surface in Areas III (East), IV, V and VI (West) during the JARPA (1991/92–2004/05), JARPAIL (2005/06–2013/14) and Japanese dedicated whale sighting (2014/15) surveys.

Type of marine debris	Metal (Total number=14)				Petrochemical products (Total number=148)												Other (Total number=1)		Sub total		Total		
	Can		Drum (≤200 L)		buoy /float*		Bottle		Container		Fender		Net		Other plastic products		Styrofoam products					Other products*	
AREA / Type of searching effort	on	off	on	off	on	off	on	off	on	off	on	off	on	off	on	off	on	off	on	off	on	off	
AREA III (East)			1		4		1	1							1						7	1	8
AREA IV			2	4	37	10			1				1	1	8	4		1		51	19	70	
AREA V	2		1	3	35	14	3		2		5	3	2		1					52	20	72	
AREA VI (West)			1		7	5														8	5	13	
Total	2	0	5	7	83	29	4	1	3	0	5	3	3	0	2	1	10	4	1	0	118	45	163

Buoys/floats/fenders were floating as single object, however, at least in six cases, several buoy/fenders were observed; those cases were counted as a single observation. Other plastic products were rope and ball. Other products were unknown material square boxes.

*Material of buoys/floats was considered to be plastic, in addition to Styrofoam and rubber.

Entanglements

Observations of the external part of the bodies of the whales were made onboard the research base vessel as shown in Figure 4. All cases of entanglements (attached objects) in Antarctic minke whales (sampled by the JARPA and JARPAIL ($n=10,660$)) were recorded. Furthermore scars and marks in the body of whales possibly produced by entanglements was examined for whales sampled under the JARPAIL ($n=3,883$). The latter analysis was based on JARPAIL surveys, when more detailed body observations, supported by the use of digital cameras, started.

The relationship between body length and body weight of Antarctic minke whales was compared between whales with and without entanglements ($n=8,705$). This was made to examine the body condition of the whales with entanglements.

RESULTS

Marine debris on the sea surface

A total of 163 records of marine debris were made (14 metals, 148 petrochemical products and one other) on the sea surface (Table 1). Buoys/floats (petrochemical) accounted for 69% of all marine debris. Debris was found throughout all research areas; however, the DI was higher in Areas IV and V particularly during the JARPAIL period (Table 2, Figures 5a and 5b). The most southerly debris was a buoy found in area V (Ross Sea) at 74°S, 176°W.

The highest DI was recorded in Area IV and V (DI: 0.15). The average DI in the four Areas was 0.13 (Table 2). DI for buoys/floats ranged from zero to 0.35 and these increased suddenly in Areas IV and V after the 2005/06 season and it peaked at the 2007/08 season and then decreased (Figure 6).

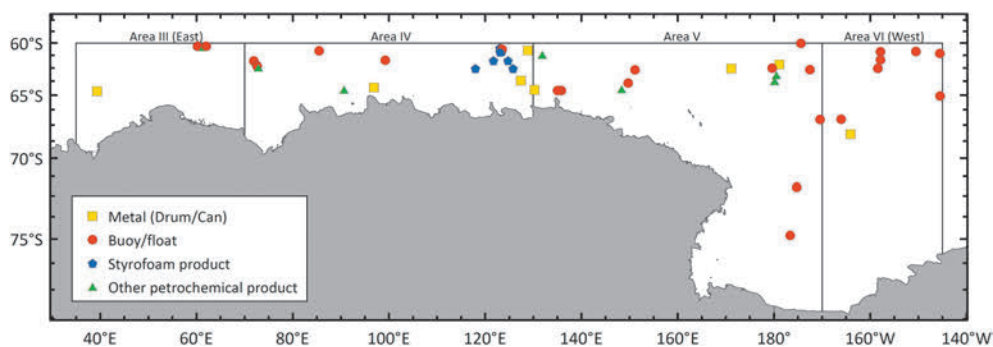

Figure 5a. Distribution of marine debris found during the JARPA surveys (1987/89–2004/05).

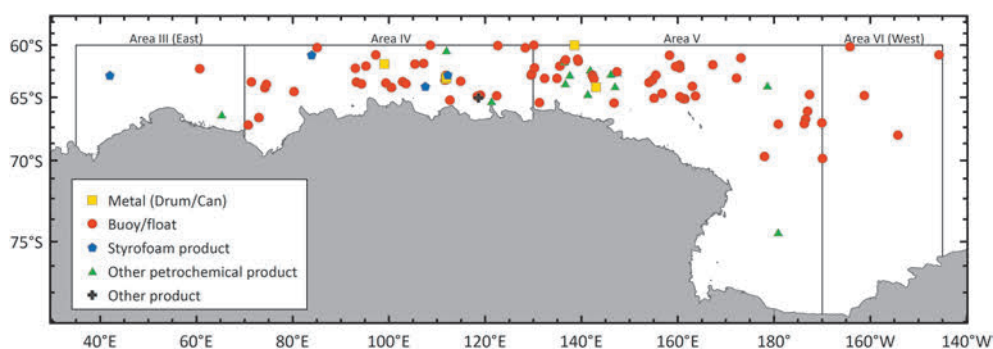

Figure 5b. Distribution of marine debris found during the JARPAII (2005/06–2013/14) and Japanese dedicated whale sighting (2014/15) surveys.

Table 2

The density indices (DI, number of marine debris per 100 n. miles) during JARPA (1995/96–2004/05), JARPAII (2005/06–2013/14) and Japanese dedicated whale sighting survey (2014/15).

Area (95/96–14/15)	Searching distance (n.miles)	Number of marine debris (on effort)	Density index (number of marine debris per 100 n.miles)
Area III (East)	14,570	7	0.05
Area IV	34,638	51	0.15
Area V	34,554	52	0.15
Area VI (West)	10,096	8	0.08
Total	93,857	118	0.13

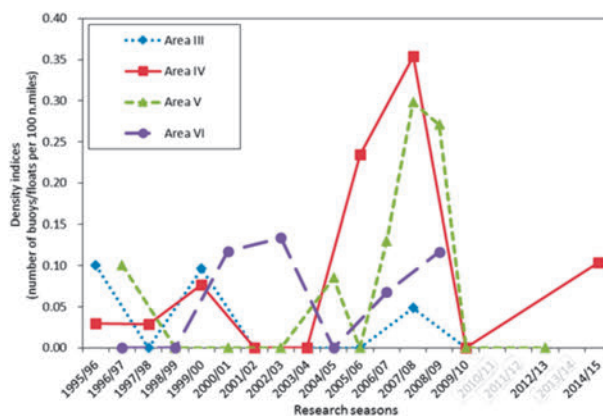

Figure 6. Density indices by season/area of sighted buoys/floats during JARPA (1995/96–2004/05), JARPAII (2005/06–2013/14) and Japanese dedicated whale sighting (2014/15) surveys.

Observation of debris in whale's stomachs

A total of 69 out of the 10,660 Antarctic minke whales examined had ingested marine debris and objects other than prey (Table 3). Feathers accounted for 44 cases, stones in six cases, pieces of wood in eight cases and plastics in nine cases. In 36 cases, debris and objects other than prey was found in the fore and main stomach.

The occurrence of plastic debris in body of whales per 100 Antarctic minke whales examined was calculated at 0.08. The size of solid objects (stone, wood, plastic) was less than 100×100 mm (Figure 7). There were two

occurrences (one plastic bag and one small wood scantling) in which the size of the objects was more than 100×100 mm.

There were no differences in the relationship between body length and body weight of Antarctic minke whales with or without debris in their stomachs (Figure 8).

No debris and objects other than prey was found in the stomachs of the 16 dwarf minke whales examined. In the case of the fin whales, only one animal had ingested objects other than prey (two pieces of feathers).

Table 3

Marine debris and objects other than prey ingested by the Antarctic minke whales sampled by JARPA and JARPAL surveys (1987/88–2013/14).

Antarctic minke whale		Marine debris and objects other than prey										Total	
Research season	Sample size	Feather		Stone		Wood		Plastic		Others			
1987/88	272	—	—	—	—	—	—	1	(0)	—	—	1	(0)
1988/89	236	—	—	—	—	—	—	—	—	—	—	—	—
1989/90	326	—	—	—	—	—	—	—	—	—	—	—	—
1990/91	323	—	—	—	—	—	—	—	—	—	—	—	—
1991/92	288	—	—	—	—	1	(0)	1	(0)	—	—	2	(0)
1992/93	327	2	(2)	—	—	1	(0)	1	(0)	—	—	4	(2)
1993/94	330	—	—	—	—	1	(0)	1	(0)	—	—	2	(0)
1994/95	330	—	—	—	—	—	—	—	—	—	—	—	—
1995/96	439	—	—	—	—	—	—	—	—	—	—	—	—
1996/97	440	8	(7)	1	(0)	—	—	—	—	—	—	9	(7)
1997/98	438	4	(0)	—	—	—	—	—	—	—	—	4	(0)
1998/99	389	1	(0)	1	(1)	1	(0)	1	(0)	—	—	4	(1)
1999/00	439	—	—	—	—	1	(0)	2	(0)	—	—	3	(0)
2000/01	440	—	—	—	—	2	(2)	1	(0)	—	—	3	(2)
2001/02	440	1	(0)	1	(0)	—	—	—	—	—	—	2	(0)
2002/03	440	2	(1)	—	—	—	—	1	(1)	1	(0)	4	(2)
2003/04	440	4	(3)	1	(0)	—	—	—	—	1	(1)	6	(4)
2004/05	440	8	(3)	1	(0)	1	(0)	—	—	—	—	10	(3)
2005/06	853	11	(11)	—	—	—	—	—	—	—	—	11	(11)
2006/07	505	—	—	—	—	—	—	—	—	—	—	—	—
2007/08	551	—	—	—	—	—	—	—	—	—	—	—	—
2008/09	679	—	—	1	(1)	—	—	—	—	—	—	1	(1)
2009/10	506	2	(2)	—	—	—	—	—	—	—	—	2	(2)
2010/11	170	—	—	—	—	—	—	—	—	—	—	—	—
2011/12	266	1	(1)	—	—	—	—	—	—	—	—	1	(1)
2012/13	103	—	—	—	—	—	—	—	—	—	—	—	—
2013/14	250	—	—	—	—	—	—	—	—	—	—	—	—
Total	10,660	44	(30)	6	(2)	8	(2)	9	(1)	2	(1)	69	(36)

All items were found in the stomach and duodenal ampulla except for three feathers, one small stone and one plastic piece found in the oral cavity, small intestine and anus respectively. The 'Others' includes one small rubber piece and one small mineral matter such as coal. (Number in parentheses): number of marine debris and objects other than prey found in the fore stomach and main stomach.

Entanglements

Only four cases of entanglements were found in a total of 10,660 Antarctic minke whales examined (Table 4, Figure 9). Those involved fishing hooks, monofilament fishing lines, ropes and packing bands. There were no differences in the relationship between body length and body weight of Antarctic minke whales with or without entanglements (Figure 8). At least five out of 3,883 Antarctic minke whales examined in JARPAL had scars presumably derived from entanglements (Figure 10).

DISCUSSION

Evidence from remote oceanic islands suggested a southward-decreasing, strong latitudinal gradient in litter densities from subtropical and temperate waters through the subtropical convergence to polar front and beyond (i.e. there is a clear trend in marine debris accumulation with latitude) (Barnes, 2005; Gregory and Ryan, 1997).

Matsumura and Nasu (1997) reported the results of sighting surveys showing the distribution of floating marine debris in the North Pacific Ocean and its adjacent

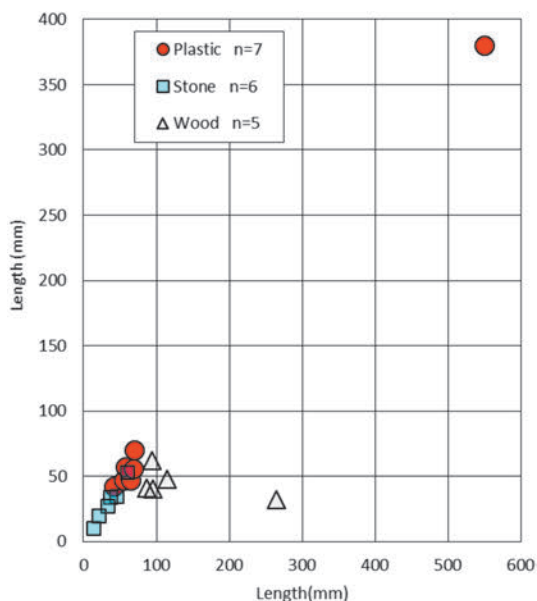

Figure 7. Size of marine debris ingested by Antarctic minke whales sampled by JARPA and JARPAII surveys (1987/88–2013/14).

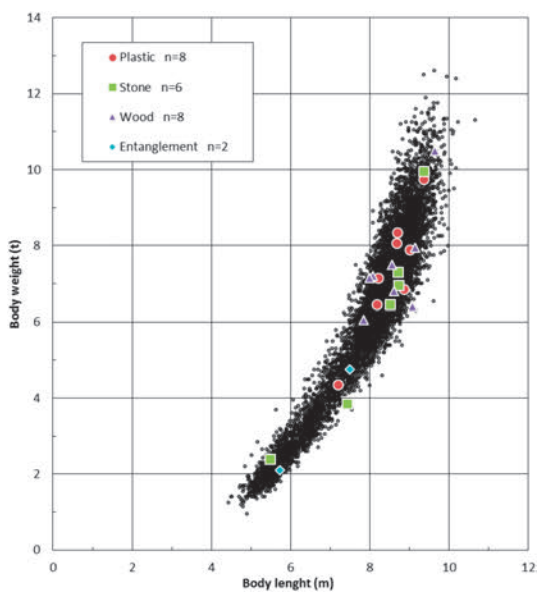

Figure 8. Relation of body length and body weight in Antarctic minke whales ($n=8,705$) for whales with and without debris in their stomachs (or entanglements).

waters in the period 1987–1991. These surveys covered approximately 926,000 n.miles and counted 136,338 pieces of marine debris (including natural objects). About 60% of marine debris accounted for petrochemical debris (e.g. fishing gear, styrofoam, other plastic products). Total debris densities in coastal waters were 20–40 objects per square n. mile, while the density in the north equatorial current area (5° to 15°N, across the central Pacific) was about 0.2 objects per square n. mile, and 1–3 objects per square n. mile in the subarctic boundary area (35° to 45°N) (Matsumura and Nasu, 1997).

The DI in our study (Table 2) was compared with the results by Matsumura and Nasu (1997). The DI in the Antarctic is lower by two orders of magnitude in comparison with the North Pacific Ocean and its adjacent waters. Thus our observations prove that the Antarctic waters have a very low density of marine debris on the sea surface.

Sources of marine debris in the Antarctic include fishing, and research/tourism vessels, but also global oceanic debris drifting across the Polar Front. Fishing operations are important sources of marine debris in the Antarctic, contributing not only with direct fishing-related debris but also miscellaneous items (Ivar do Sul *et al.*, 2011). According to our results, fishing buoys/floats accounted for about 69% of all sighted marine debris on the sea surface. Barnes *et al.* (2010) recorded three pieces of marine debris in the Durmont D’Urville and Davis Seas (i.e. Areas IV and V): a plastic cup and two fishing buoys.

The assumption that all buoys/floats observed in the Antarctic were transported from lower latitudes is unreasonable in consideration of the barrier effects of the Polar Frontal Zone, even if it is weak. Webber and Parker (2012) showed fishing gear loss of bottom long-line fisheries targeting Antarctic toothfish (*Dissostichus mawsoni*). Since 2004/05, licensed longline vessels have conducted exploratory fishery for *Dissostichus* spp. (target species is Antarctic toothfish) in CCAMLR division subarea 58.4.1 (which overlaps with Areas IV and V), and

Table 4
List of entangled whales observed during JARPA and JARPAII surveys (1987/88–2013/14).

Research season	Specimen No.	Date	Latitude	Longitude	Body length (m)	Body weight (t)	Sex	Stomach contents	Entanglement objects	Figure 9
1995/96	065	22/12/1995	62°48’S	68°55’E	7.5	4.7	M	Empty	Fishing hook	a
2003/04	046	10/12/2003	63°10’S	54°56’E	5.7	2.1	M	Krill	Monofilament fishing line	b
2005/06	190	6/1/2006	64°26’S	72°40’E	7.8	NA	F	Krill	Rope	c
2005/06	765	5/3/2006	63°56’S	103°46’E	5.7	NA	M	Krill	Packing band	d

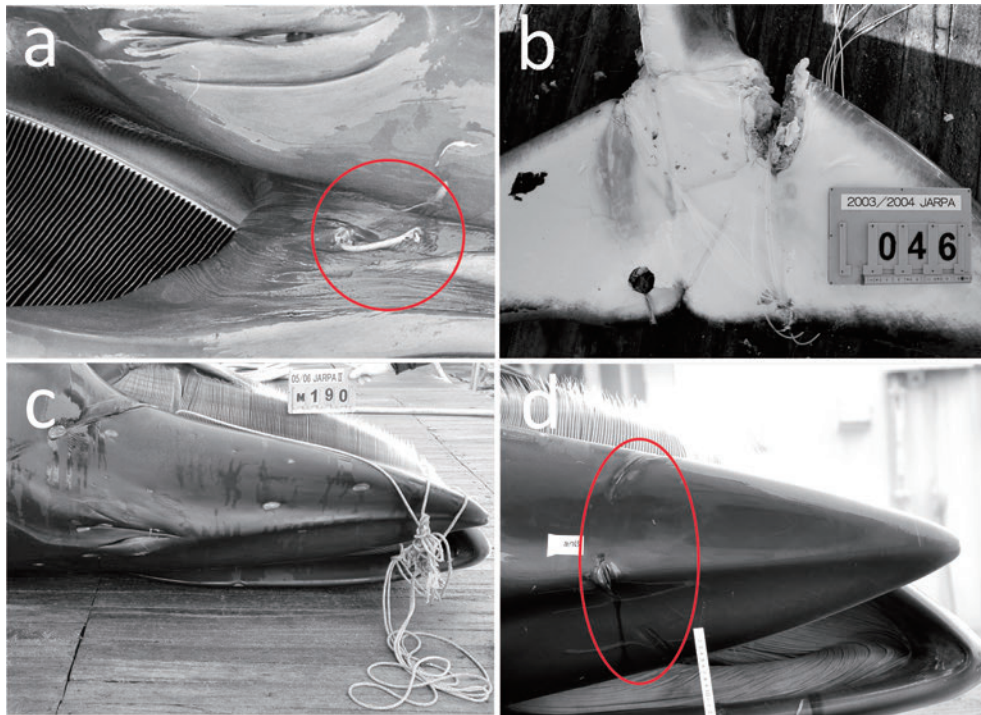

Figure 9. Four entangled Antarctic minke whales observed during JARPA and JARPAII surveys (1987/88–2013/14). (a) Fishing hook, (b) Monofilament fishing line, (c) Rope, (d) Packing band, (e) Loose packing band when a whale was being transported on the way to research base vessel.

there are high levels of IUU (illegal, unreported and unregulated) fishing conducted outside CCAMLR regulations (SC-CAMLR, 2011). The number of licensed vessels in the exploratory fishery in subarea 58.4.1 was four to seven in 2004/05 to 2007/08 seasons, however it was decreased to one to three in 2008/09 to 2014/15 seasons (SC-CAMLR, 2012a; CCAMLR, 2013; 2014; 2015). The number of sighted buoys/floats suddenly increased in Areas IV and V after the 2005/06 season and peaked at 2007/08 seasons, and then decreased. This pattern coincides with the fluctuation of longline fisheries operations (include IUU fishing).

In Iceland, six of 82 examined fin whales (commercial whaling) and in the New York area, three of 19 examined mysticetes (stranding) contained synthetics in the gut (Sadove and Morreale, 1990). The occurrence rates of marine litter ingestion obtained from stranded animals examined in the UK were 2.2% in the harbour porpoise (*Phocoena phocoena*) and 2.3% in the short-beaked common dolphin (*Delphinus delphis*) (Deaville and Jepson, 2010). We found 60 individuals with 69 pieces of marine debris and objects other than prey out of 10,660 Antarctic minke whales sampled in the Antarctic (0.56%). Among them, there were only nine cases of plastics, which is an extremely low frequency (0.08%) in comparison with other oceanic basins. Given this low frequency the effect of marine debris on whales is expected to be

low.

Entanglement of Antarctic fur seals (*Arctocephalus gazella*) was caused mostly by loop shaped debris such as packing bands (Croxall *et al.*, 1990; Arnould and Croxall, 1995). CCAMLR has prohibited and restricted the use of packing bands on fishing vessels in Conservation Measure 26-01. In this study, some entangled whales strapped with packing bands around their upper rostrums were found (Figures 9-d). Similar cases were reported in common minke whales (*B. acutorostrata*) in the Atlantic (Gill *et al.*, 2000). It has been indicated that loop shaped debris causes the entanglement of whales as well pinnipeds.

Fishing gear is the most significant source of entanglements for whales and those entanglements were reported in various waters (Laist, 1997; Simmonds, 2012). Documented interaction between whales and fisheries in the Southern Ocean included killer (*Orcinus orca*) and sperm whales (Kock *et al.*, 2006), however entanglement mortalities recorded in the case of sperm whales and possibly minke whales (SC-CAMLR, 2004; 2012b) were low. In this study, only three cases of entanglements (probably by fishing gear) were found among the 10,660 Antarctic minke whales examined.

At least five out of 3,883 Antarctic minke whales examined in JARPAII had scars presumably derived from entanglements (see Figure 10). Those scars suggested

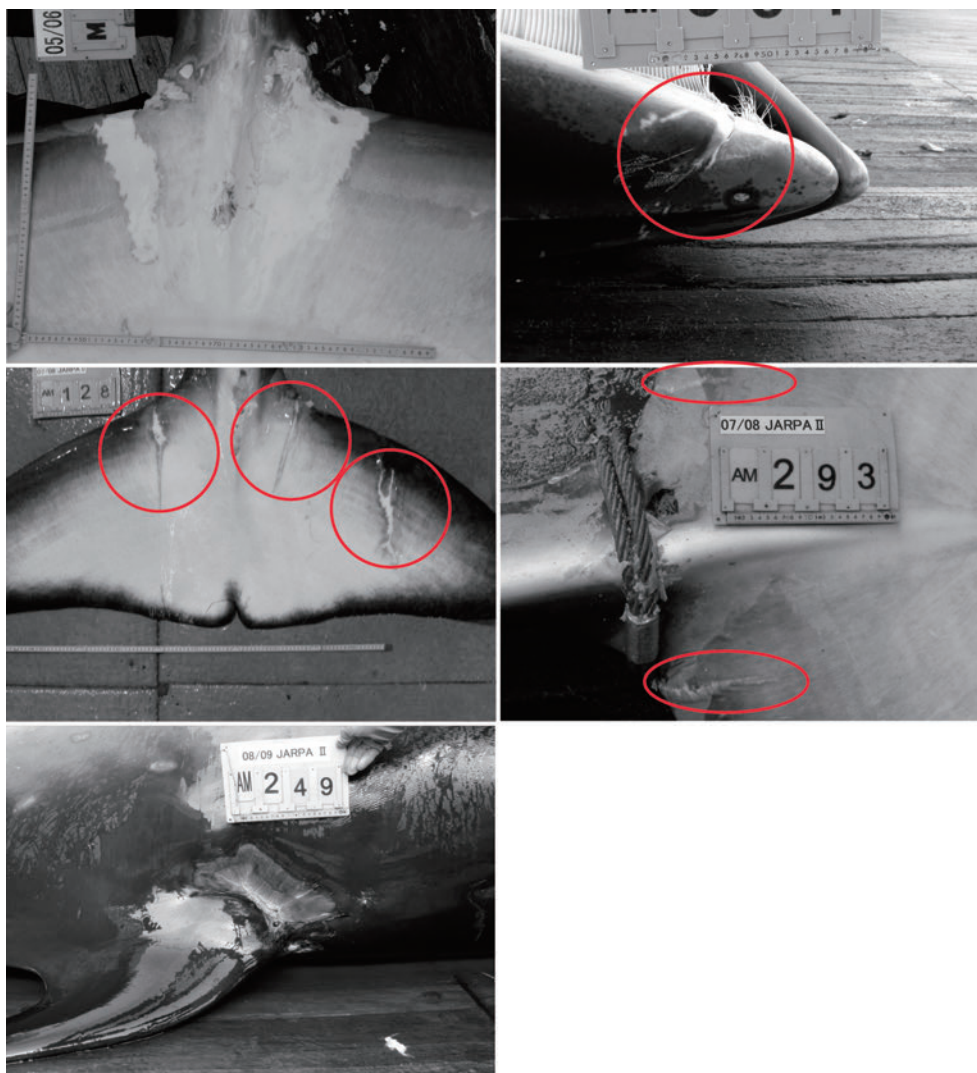

Figure 10. Five cases of Antarctic minke whales with scars probably derived from entanglements observed during JARPAII surveys (2005/06–2013/14). In the middle right-hand picture the wire rope used in the processing is also shown.

that the entanglements occurred in previous cases, but that they escaped from the obstructive objects and survived. Entanglements along the eastern seaboard of the United States and Canada during a five year period were reported as 27 cases of minke whales and 77 of humpback whales (Glass *et al.*, 2008). In Iceland, five of 95 fin whales examined showed signs of previous entanglement (Sadove and Morreale, 1990). The entanglements of Antarctic minke whales are less frequent. Therefore the level of impact of entanglements on Antarctic minke whales would be low in comparison with other oceanic basins.

CONCLUSIONS

This study provided the first comprehensive quantitative approach of examining marine debris on the sea surface and ingestion of marine debris and entanglement of whales in the Antarctic. Given the low frequencies and

indices, the impact of marine debris on whales in the Antarctic is expected to be limited. Our study provides some evidence that some degree of interaction between whales and fishery exist in the Antarctic. Webber and Parker (2012) recommended that fishing vessels and/or the CCAMLR observer should record the detailed gear loss, for estimating unaccounted fishing mortality and to reduce the loss of fishing gear. That information is also essential to understand the interaction between whales and fisheries and marine debris. Long-term surveys conducted by JARPA and JARPAII proved very useful for examining the occurrence of marine debris and entanglements in the Antarctic.

ACKNOWLEDGEMENTS

We would like to thank all of the captains, crew members, cruise leaders and researchers onboard the research

vessels of JARPA, JARPAII and Japanese dedicated whale sighting survey for their contributions in collecting the data used in this study.

REFERENCES

- Arnould, J.P.Y. and Croxall, J.P. 1995. Trends in entanglement of Antarctic fur seals (*Arctocephalus gazella*) in man-made debris at South Georgia. *Marine Pollution Bulletin* 30 (11): 707–712.
- Barnes, D.K.A. 2005. Remote islands reveal rapid rise of southern hemisphere sea debris. *Sci. World J.* 5: 915–921.
- Barnes, D.K.A., Walters, A. and Gonçalves, L. 2010. Macroplastics at sea around Antarctica. *Marine Environmental Research* 70: 250–252.
- CCAMLR. 2013. Fishery Report: Exploratory fishery for *Dissostichus* spp. in Division 58.4.1. CCAMLR, Hobart, Australia. 10 pp.
- CCAMLR. 2014. Fishery Report: Exploratory fishery for *Dissostichus* spp. in Division 58.4.1. CCAMLR, Hobart, Australia. 12 pp.
- CCAMLR. 2015. Fishery Report: Exploratory fishery for *Dissostichus* spp. in Division 58.4.1. CCAMLR, Hobart, Australia. 15 pp.
- Croxall, J.P., Rodwell, S. and Boyd, I.L. 1990. Entanglement in man-made debris of Antarctic fur seals at Bird Island, South Georgia. *Marine Mammal Science* 6: 221–233.
- Deville, R. and Jepson, P.D. (eds.). 2010. *UK Cetacean Strandings Investigation Programme (CSIP)—Final Report for the period 1st January 2005–31st December 2010*. CSIP, Institute of Zoology, Zoological Society of London, UK. 98 pp.
- Gill, A., Fairbairns, B. and Fairbairns, R. 2000. Photo-identification of the Minke Whale (*Balaenoptera acutorostrata*) around the Isle of Mull, Scotland. *Report to the Hebridean Whale and Dolphin Trust*. 88 pp.
- Glass, A.H., Cole, T.V.N., Garron, M., Merrick, R.L. and Pace III, R.M. 2008. Mortality and serious injury determinations for baleen whale stocks along the United States eastern seaboard and adjacent Canadian Maritimes, 2002–2006. U.S. Dep. Commer., *Northeast Fish. Sci. Cent. Ref. Doc.* 08–04. 18 pp.
- Government of Japan. 2005. Plan for the Second Phase of the Japanese Whale Research Program under Special Permit in the Antarctic (JARPAII)—Monitoring of the Antarctic Ecosystem and Development of New Management Objectives for Whale Resources. Paper SC/57/O1 presented to the IWC Scientific Committee, Jun 2005 (unpublished). 99 pp. [Available from the IWC Secretariat].
- Gregory, M.R. and Ryan, P.G. 1997. Pelagic plastics and other seaborne persistent synthetic debris: a review of southern hemisphere perspectives. pp. 49–66. In: J.M. Coe and D.B. Rogers (eds.) *Marine Debris, sources, impacts, and solutions*. New York. Springer-Verlag. 432 pp.
- Ivar do Sul, J.A., Barnes, D.K., Costa, M.F., Convey, P., Costa, E.S. and Campos, L. 2011. Plastics in the Antarctic environment: Are we looking only at the tip of the iceberg? *Oecologia Australis* 15 (1): 150–170.
- Kock, K.H., Purves, M.G., and Duhamel, G. 2006. Interactions between cetacean and fisheries in the Southern Ocean. *Polar Biol.* 29: 379–388.
- Laist, D.W. 1997. Impacts of marine debris: entanglement of marine life in marine debris including a comprehensive list of species with entanglement and ingestion records. pp. 99–139. In: J.M. Coe and D.B. Rogers (eds.) *Marine Debris, sources, impacts, and solutions*. New York. Springer-Verlag. 432 pp.
- Matsumura, S. and Nasu, K. 1997. Distribution of floating debris in the North Pacific Ocean: sighting surveys 1986–1991. pp. 15–24. In: J.M. Coe and D.B. Rogers (eds.) *Marine Debris, sources, impacts, and solutions*. New York. Springer-Verlag. 432 pp.
- Nishiwaki, S., Ishikawa, H. and Fujise, Y. 2006. Review of general methodology and survey procedure under the JARPA. Paper SC/D06/J2 presented to the JARPA review meeting called by the IWC, December 2006 (unpublished). 47 pp. [Available from the IWC Secretariat].
- Nishiwaki, S., Ishikawa, H., Goto, M., Matsuoka, K. and Tamura, T. 2014. Review of general methodology and survey procedure under the JARPAII. Paper SC/F14/J2 presented to the JARPAII review meeting called by the IWC, February 2014 (unpublished). 34 pp. [Available from the IWC Secretariat].
- Sadove, S.S. and Morreale, S.J. 1990. Marine mammal and sea turtle encounters with marine debris in the New York Bight and the northeast Atlantic. pp. 562–570. In: R.S. Shomura and M.L. Godfrey (eds.) *Proceedings of the Second International Conference on Marine Debris, 2–7 April 1989, Honolulu, Hawaii*. NOAA Tech. Memo. NMFS-SWFSC-154. 1274 pp.
- SC-CAMLR. 2004. Report of the Working Group on Fish Stock Assessment. In: *Report of the twenty-third Meeting of the Scientific Committee (SC-CAMLR-XXIII)*, Annex 5. CCAMLR, Hobart, Australia: 338–657.
- SC-CAMLR. 2011. Report of the Working Group on Fish Stock Assessment (APPENDIX N: Fishery Report: Exploratory fishery for *Dissostichus* spp. in Division 58.4.1). In: *Report of the thirtieth Meeting of the Scientific Committee (SC-CAMLR-XXX)*, Annex 7. CCAMLR, Hobart, Australia. 14 pp.
- SC-CAMLR. 2012a. Report of the Working Group on Fish Stock Assessment (APPENDIX Q: Fishery Report: Exploratory fishery for *Dissostichus* spp. (TOT) in Division 58.4.1). In: *Report of the thirty-first Meeting of the Scientific Committee (SC-CAMLR-XXXI)*, Annex 7. CCAMLR, Hobart, Australia. 12 pp.
- SC-CAMLR. 2012b. Report of the Working Group on Fish Stock Assessment. In: *Report of the Thirty-first Meeting of the Scientific Committee (SC-CAMLR-XXXI)*, Annex 7. CCAMLR, Hobart, Australia: 265–377.
- Simmonds, M.P. 2012. *Cetaceans and Marine Debris: The Great*

Unknown. *Journal of Marine Biology*. Vol. 2012 Article ID 684279, doi:10.1155/2012/684279. 8 pp.

Webber, D.N. and Parker, S.J. 2012. Estimating unaccounted

fishing mortality in the Ross sea region and Amundsen Sea (CCAMLR subareas 88.1 and 88.2) bottom longline fisheries targeting Antarctic toothfish. *CCAMLR Science* 19: 17–30.

Technical Report-Note (not peer reviewed)

A summary of photo-id information of blue, southern right and humpback whales collected by JARPA/JARPAII in the Indo-Pacific region of the Antarctic

Koji MATSUOKA* and Luis A. PASTENE

Institute of Cetacean Research, Toyomi-cho, 4–5 Chuo-ku, Tokyo 104–0055, Japan

*Contact e-mail: matsuoka@cetacean.jp

The IWC Scientific Committee (IWC SC) conducted assessments of Antarctic blue (*Balaenoptera musculus intermedia*), southern right (*Eubalaena australis*) and humpback (*Megaptera novaeangliae*) whales. One of the techniques used by the IWC SC to investigate distribution, movement and abundance is photo-identification (photo-id) of whales. Photo-id data obtained by JARPA and JARPAII surveys have the potential to contribute to the assessments of those species.

During the JARPA and JARPAII austral summer surveys in the Indo-Pacific region of the Antarctic, which include IWC Management Areas III E (35°E–70°E), IV (70°E–130°E), V (130°E–170°W) and VI W (170°W–145°W), photo-id experiments on blue, southern right and humpback whales were conducted on an opportunistic basis. Photo-id experiments were conducted in conjunction with biopsy experiments. The dedicated sighting (SV) and the sighting and sampling (SSV) vessels conducting line transect surveys under JARPA and JARPAII approached the whales for obtaining pictures of natural marks, which can be used for individual identification e.g. scars, shape of dorsal fin or mottled pigmentation pattern in the case of the blue whale (Figure 1); scars, head callosities pattern in the case of the southern right whale (Figure 2); scars, shape of dorsal fin, lateral marking and ventral fluke coloration in the case of the humpback whale (Figure 3).

Between the austral summer seasons 1992/93 and 2004/05 (JARPA), photographs were taken using 35 mm SLR databack cameras equipped with 70-up to 300 mm lenses and motor drive. Black and white 400 ASA films (*Ilford* HP5) were used. From the 2005/06 season (JARPAII), digital Nikon 70D cameras equipped with 100–300 mm lens were used.

After each austral summer season, the best pictures were selected (LAP for the pictures taken between 1989/90 and 2004/05 and KM for the pictures taken from 2005/06), and these pictures were entered into the Institute of Cetacean Research (ICR)'s catalogue.

Tables 1a, 1b and 1c summarize the number of pic-

tures for blue, southern right and humpback whales, respectively, by survey. Table 2 shows the total number of pictures in the ICR catalogue. A total of 3,108 photographs (529 for blue, 914 for southern right and 1,665 for humpback whales) were collected and selected from 1989/90 to 2010/11 seasons (22 seasons). The number



Figure 1. Example of dorsal fin shape and mottled pigmentation as natural marks for photo-id of Antarctic blue whales.



Figure 2. Example of head callosities as natural marks for photo-id of southern right whales.



Figure 3. Example of ventral fluke pigmentation pattern as natural marks for photo-id of humpback whales.

Table 1a

Number of Antarctic blue whale photographs taken during JARPA and JARPAII surveys by IWC Management Areas and austral summer season.

Survey	Season	IWC Areas				Number of photographs
		III E	IV	V	VI W	
JARPA	1987/88	—	—	—	—	0
	1988/89	—	—	—	—	0
	1989/90	—	—	—	—	0
	1990/91	—	—	—	—	0
	1991/92	—	—	—	—	0
	1992/93	—	—	33	—	33
	1993/94	—	9	—	—	9
	1994/95	—	—	16	—	16
	1995/96	7	3	—	—	10
	1996/97	—	—	6	2	8
	1997/98	1	4	—	—	5
	1998/99	—	—	21	0	21
	1999/00	22	6	—	—	28
	2000/01	—	—	0	0	0
	2001/02	0	5	—	—	5
2002/03	—	—	0	6	6	
2003/04	5	4	—	—	9	
2004/05	—	—	0	3	3	
Sub-total		35	31	76	11	153
JARPAII	2005/06	59	113	0	—	172
	2006/07	—	—	18	0	18
	2007/08	60	10	0	—	70
	2008/09	—	—	24	39	63
	2009/10	21	32	0	—	53
	2010/11	—	—	0	0	0
	Sub-total		140	155	42	39
Total		175	186	118	50	529

Table 1b

Number of southern right whale photographs taken during JARPA and JARPAII surveys by IWC Management Areas and austral summer season.

Survey	Season	IWC Areas				Number of photographs
		III E	IV	V	VI W	
JARPA	1987/88	—	—	—	—	0
	1988/89	—	—	—	—	0
	1989/90	—	—	—	—	0
	1990/91	—	—	—	—	0
	1991/92	—	39	—	—	39
	1992/93	—	—	24	—	24
	1993/94	—	9	—	—	9
	1994/95	—	—	0	—	0
	1995/96	—	12	—	—	12
	1996/97	—	—	0	—	0
	1997/98	—	94	—	—	94
	1998/99	—	—	0	—	0
	1999/00	—	9	—	—	9
	2000/01	—	—	2	—	2
	2001/02	—	33	—	—	33
2002/03	—	—	10	—	10	
2003/04	—	6	—	—	6	
2004/05	—	—	5	—	5	
Sub-total		0	202	41	0	243
JARPAII	2005/06	—	495	—	—	495
	2006/07	—	—	0	—	0
	2007/08	—	144	18	—	162
	2008/09	—	—	0	—	0
	2009/10	—	14	—	—	14
	2010/11	—	—	0	—	0
	Sub-total		0	653	18	0
Total		0	855	59	0	914

of photographs for blue whales were 140, 155, 42 and 39 in Areas III E, IV, V and VI W, respectively. The numbers of photographs for southern right whales were 653 and 18 in Areas IV and V, respectively. The numbers of photographs for humpback whales were 12, 903, 235 and 51 in Areas III E, IV, V and VI W, respectively.

Analyses of photographs collected during the JARPA/JARPAII have the potential to contribute to a better understanding of the pattern of movement and residence of these species in the feeding grounds. It could assist the interpretation of abundance trends and quantitative distribution studies south of 60°S.

Table 1c

Number of humpback whale photographs taken during JARPA and JARPAII surveys by IWC Management Areas and austral summer season.

Survey	Season	IWC Areas				Number of photographs
		III E	IV	V	VI W	
JARPA	1987/88	—	—	—	—	0
	1988/89	—	—	—	—	0
	1989/90	—	19	—	—	19
	1990/91	—	—	8	—	8
	1991/92	—	26	—	—	26
	1992/93	—	—	69	—	69
	1993/94	—	51	—	—	51
	1994/95	—	—	43	—	43
	1995/96	3	31	—	—	34
	1996/97	—	—	4	15	19
	1997/98	7	52	—	—	59
	1998/99	—	—	—	—	0
	1999/00	14	37	—	—	51
	2000/01	—	—	13	17	30
	2001/02	3	14	—	—	17
	2002/03	—	—	7	0	7
	2003/04	9	11	—	—	20
2004/05	—	—	11	—	11	
	Sub-total	36	241	155	32	464
JARPAII	2005/06	0	328	—	—	328
	2006/07	—	—	62	34	96
	2007/08	12	78	—	—	90
	2008/09	—	—	165	17	182
	2009/10	—	497	—	—	497
	2010/11	—	—	8	—	8
		Sub-total	12	903	235	51
	Total	48	1,144	390	83	1,665

Further information on movement and distribution can be optimized if these photographs are examined in conjunction with photographs from other surveys and regions. In fact, scientists from the ICR have conducted

Table 2

Summary of the number of pictures for each species during JARPA and JARPAII surveys (1987/88–2010/11).

Species	JARPA	JARPAII	Total
Blue whale	153	376	529
Southern right whale	243	671	914
Humpback whale	464	1,201	1,665
Total	860	2,248	3,108

research collaboration with several foreign scientists and several photo-id matches between different regions have been reported (e.g. Bannister *et al.*, 1999; Rock *et al.*, 2006). Further collaboration is being conducted with members of the IWC SC (e.g. Olson *et al.*, 2018).

Pictures are available for cooperative studies under established ICR protocols for data access and collaboration. See details in the home page of the ICR.

ACKNOWLEDGEMENTS

We acknowledge the captains, crew members and researchers for their effort in collecting photo-id data during the JARPA and JARPAII surveys. We thank Hitomi Sato for her assistance in constructing the ICR’s photo-id database.

REFERENCES

- Bannister, J.L., Pastene, L.A. and Burnell, S.R. 1999. First record of movement of a southern right whale (*Eubalaena australis*) between warm water breeding grounds and the Antarctic Ocean, south of 60°S. *Mar. Mammal Sci.* 15 (4): 1337–1342.
- Olson, P.A., de Boer, M., Kennedy, A., Double, M.C., Matsuoka, K., Pastene, L.A. and Findlay, K. 2018. Photo-identification of Antarctic blue whales: new data from 1998 and 2015–2018. Paper SC/67b/PH/02 presented to the IWC Scientific Committee, May 2018 (unpublished). 5 pp. [Available from the IWC Secretariat].
- Rock, J., Pastene, L.A., Kaufman, G., Forestell, P., Matsuoka, K. and Allen, J. 2006. A note on East Australia Group V Stock humpback whale movement between feeding and breeding areas based on photo-identification. *J. Cetacean Res. Manage.* 8 (3): 301–305.

Commentary

The views expressed here are those of the author and do not necessarily reflect the views of the Institute of Cetacean Research

Ethics of Whaling: Is whaling truly immoral?

Kayo OHMAGARI

Institute of Cetacean Research, Toyomi-cho 4–5, Chuo-ku, Tokyo 104–0055, Japan

INTRODUCTION

In recent years, the impact of human activities on the environment, in particular habitat degradation and destruction, and resource over-exploitation, have been of increasing concern which led to a rise of environmentalism. As a result, the relationship between humans, the natural environment, and other living organisms is being reconsidered. This has led to examining alternatives to traditional consumptive use-oriented relationships between humans and nature, as well as moral and ethical responsibilities toward future generations.

A part of this debate relates to whaling, where the international community is split primarily along two opposing sides. One view denies the conventional consumptive use-oriented relationship between humans and whales, and claims that the only acceptable whale use in the 21st century is non-consumptive use, such as whale watching. According to this view, whales are an international common heritage which must be ‘preserved,’ as opposed to ‘conserved,’ for future generations. Moreover, whaling should not be permitted because it is against ethics that ‘there are certain cultural norms, like cannibalism, that are in violation of our basic approach to maintaining our civilization’ (Wetson cited in Eilperin, 2006).

In contrast, the other view supports the maintenance of a traditional relationship between humans and whales, where hunting and dietary use should be allowed as long as such use is sustainable. Since whales are used for food, the claim that whaling and eating whale products are immoral/unethical is not acceptable. Solely non-consumptive use of whales is simply not justifiable as long as resources are abundant. This view acknowledges traditional users’ right to the resource, and opposes anti-utilization when it is based strictly on sentiment.

This brief paper attempts to clarify moral/ethical arguments against whaling, their meanings, and if such claim is indeed justifiable.

PHILOSOPHICAL DEBATE

To understand the claim that whaling is unethical and

immoral, two philosophical concepts, namely ethics and morality should be defined and discussed. Singer (2018) defines that ‘ethics, also called moral philosophy, the discipline concerned with what is morally good or bad, right or wrong.’ Furthermore, he states that ethics’ major concerns include the nature of ultimate value and the standards by which human actions can be judged right or wrong.’ In other words, ethics or morality implies something of objective and normative value to be accepted by all people.

However, there is an opposing view, moral relativism, which argues that such objective or universal morality does not exist, but is only relative to a group, person, or society/culture. This school of thought was largely influenced by anthropology (Gowans, 2018), such as ‘...moral values are relative to culture and that there is no way of showing that the values of one culture are better than those of another’ (American Anthropological Association Executive Board, 1947). Reflecting these varied views on ethics, morality defined by Gert and Gert (2017) is more comprehensive: ‘1. descriptively to refer to a code of conduct put forward by a society or a) some other group, such as religion, or b) accepted by an individual for his/her own behavior or 2. normatively refer to a code of conduct that, given specified conditions, would be put forward by all rational persons.’ As there are two opposing views of moral/ethics, the possibility of an objective morality has become one of the constant themes of ethics (Singer, 2018).

DISCUSSION

When someone claims that whaling is immoral/unethical, which morals does he/she refer to, universal or specific to a society/culture? Universal moral or ethical argument against whaling is persuasive only if the population or resource cannot be sustainably used, and such use would lead the species to go extinct, with nothing left for the future generations. However, many whale populations have recovered and a risk averse resource management tool to ensure calculation of safe quotas, Revised Management Procedure (RMP), has been developed. There

is therefore no sound scientific basis to oppose whaling because whales can be sustainably harvested and utilized for human consumption.

Conservation of biological diversity is a globally shared concern and a part of newly emerging normative values, however, the concern here is the conservation of the stock or species but not the protection of an individual animal. As long as survival of species is not at risk, the moral argument against whaling is difficult to justify as it is a matter of animal rights or animal welfare but not conservation.

There are a wide variety of edible plant and animals around the world, but somehow lines are drawn concerning what to eat or good to eat and ignore the rest as inedible, disgusting or sacred. Some people eat whales while others do not. The claim that whaling is immoral based on the lack of shared food habits is merely a reflection of a specific value. Nevertheless, provocative words, such as bloodbath, barbaric and cruel practice, are often used to criticize whaling and to justify their position against whaling.

An attempt to convince the other side by claiming that its own morality is superior to the others' can be regarded as 'ethical egoism' (Gert and Gert, 2017). Arguments of immorality against whaling may be a good example of this phenomenon. To be convincing, the claim is often enforced with an evolutionary twist. Attitudes towards whales are frequently used as a measurement stick for the progress of animal rights discourse: liberation from racism, sexism, and finally to speciesism (Kalland, 1993). Compassion for whales is considered by some as an indicator of personal as well as social maturity (Scheffer, 1991) and being considerate to whales has become a prerequisite for membership in the 'world community' (Fuller, 1991). In other words, for those arguing against whaling, advanced civilized society and its citizenry should exempt whales from the universally accepted principle of sustainable use because whales are special magnificent creatures, 'the humans of the ocean' (Gylling-Nielsen, 1987). Thus, personified whales deserve certain rights and exemption from dinner tables.

CONCLUSION

Do you perceive whaling as immoral and is this position

justifiable? The word moral/ethic has strong connotations that such values have to be absolute and universal. However, there is a philosophical debate between normative vs. specific which is manifested in the whaling debate. On one hand, those who claim whaling immoral assert their morality has evolved to be normative and superior to the others so that the rest should embrace this norm. On the other hand, others consider such claim to be invalid because such position is a mere reflection of a specific value only acceptable to certain groups and people, and consider their argument to be ethical egoism. An answer to the question whether whaling is immoral or not lies in one's personal belief. Whaling is immoral for some, but it is not for others.

REFERENCES

- American Anthropological Association Executive Board. 1947. Statement on Human Rights. *American Anthropologist* 49: 539–543.
- Eilperin, J. 2006. Whaling Agency Faces a Possible Shift. *Washington Post*, June 2.
- Singer, P. 2018. Ethics. *Encyclopedia Britannica*. Available at <http://www.britannica.com> (Membership required). Access date: September 20, 2018.
- Fuller, K.S. 1991. Letter to the Ambassadors of Whaling Nations, dated May 24. Washington, WWF.
- Gert, B. and Gert, J. 2017. The Definition of Morality. *Stanford Encyclopedia of Philosophy*. (Fall 2017 Edition), Edward N. Zalta (ed.). Available at <http://plato.stanford.edu/archives/fall2017/entries/morality-definition/>. Access date: September 21, 2018.
- Gowans, C. 2018. Moral Relativism. *Stanford Encyclopedia of Philosophy*. (Summer 2018 Edition). Edward N. Zalta (ed.). Available at <http://plato.stanford.edu/archives/sum2018/entries/moral-relativism/>. Access date: September 21, 2018.
- Gylling-Nielsen, M. 1987. Havets Mennesker. *Greenpeace Magasinet*, no. 1.
- Kalland, A. 1993. Management by Totemization: Whale Symbolism and the Anti-Whaling Campaign. *Arctic* 46 (2): 124–133.
- Scheffer, V. 1991. Why Should We Care About Whales? pp. 17–19. In: N. Davies, A.M. Smith, S.R. Whyte, and V. Williams (eds.) *Why Whales?* The Whale and Dolphin Conservation Society, Bath, U.K. 23 pp.

International meetings

Participation of scientists of the Institute of Cetacean Research in International Meetings in 2018

Annual meeting of the International Whaling Commission Scientific Committee (IWC SC)

The International Whaling Commission (IWC) is an international body set up by the terms of the International Convention for the Regulation of Whaling (ICRW), which was signed in Washington, D.C., United States, on 2 December, 1946 to 'provide for the proper conservation of whale stocks and thus make possible the orderly development of the whaling industry.' One of the important components of the IWC is the Scientific Committee (SC), which meets annually.

The 2018 meeting of the IWC SC was held at the Rikli Balance Hotel, Bled, Slovenia, from 21 April to 6 May. A total of ten scientists from the Institute of Cetacean Research (ICR) participated in the meeting (Fujise, Kato, Pastene, Tamura, Matsuoka, Goto, Yasunaga, Konishi, Taguchi and Inoue). They presented seven documents at plenary sessions, nine documents at the *Ad hoc* Working Group on Abundance Estimates, Stock Status and International Cruises, one document at the Working Group on Ecosystem Modelling, two documents at the Working Group on Stock Definition and DNA Testing, one document at the Sub-Committee on Northern Hemisphere Whale Stocks, and one document at the Sub-Committee on Other Southern Hemisphere Whale Stocks.



Rikli Balance Hotel, Bled, Slovenia.

In 2018, ICR scientists also participated in several inter-essional meetings of the IWC SC: a) Workshop on Western North Pacific common minke whale stock structure in preparation for the start of the *Implementation Review*, held at the Fisheries Agency of Japan (FAJ)'s Crew House, Tokyo, Japan, from 12-13 February (Pastene, Goto, Taguchi and Inoue); b) Second *Implementation Review* Workshop on western North

Pacific Bryde's whales, held at the FAJ's Crew House, Tokyo, Japan from 14-16 February (Pastene, Hakamada and Inoue); c) Fourth workshop on large whale entanglement issues, held at the Center for Coastal Studies, Provincetown, USA from 5-7 June (Kato and Matsuoka); d) TAG and Planning Meetings for the 2019 IWC-POWER Cruises in the North Pacific, held at the FAJ's Crew House, Tokyo, Japan from 12-16 October (Kato, Matsuoka, Hakamada and Takahashi).

Marine Ecosystem Assessment for the Southern Ocean 2018 (MEASO18)—Assessing Status and Trends of Habitats, Key Species and Ecosystems in the Southern Ocean

The MEASO18 was held at the C3 Convention Center, Hobart, Australia from 9-13 April. One scientist from ICR participated in the meeting (Pastene). He presented a document titled 'Site-fidelity, movement ranges and abundance of southern right whales in the Antarctic Indo region inferred from genetic tagging.' The presentation was made under Theme 1 of MEASO18, 'Assessment.'



C3 Convention Center, Hobart, Australia.

Annual meeting of the Convention on the Conservation of Antarctic Marine Living Resources —Working Group on Ecosystem Monitoring and Management (CCAMLR-EMM)

The Convention on the Conservation of Antarctic Marine Living Resources (CCAMLR) is part of the Antarctic Treaty System. The Convention was opened for signature on 1 August 1980 and entered into force on 7 April 1982 thereby establishing the Commission for the Conservation of Antarctic Marine Living Resources. The goal is to preserve marine life and environmental integrity in and near

Antarctica. It was established in large part in response to concerns that an increase in krill catches in the Southern Ocean could have a serious impact on populations of other marine life which are dependent upon krill for food. The CCAMLR has a Scientific Committee and several Working Groups including the Working Group on Ecosystem Monitoring and Management (EMM), which meet annually.

The 2018 meeting of the CCAMLR-EMM was held at the British Antarctic Survey, Cambridge, UK from 9-13 July. One scientist from ICR participated in the meeting (Pastene). He presented a document titled 'Population identity, site-fidelity, movement ranges and preliminary estimates of abundance of southern right whales in the Antarctic Indian sector inferred from genetic marker.' The presentation was made under the agenda item 'Ecosystem monitoring and observations.'



British Antarctic Survey, Cambridge, UK.

Annual meeting of the North Pacific Marine Science Organization (PICES)

The North Pacific Marine Science Organization (PICES) is an intergovernmental organization that promotes and coordinates marine scientific research in the North Pacific Ocean and provides a mechanism for information and data exchange among scientists in its member countries.

The 2018 meeting of the PICES was held at the Workpia Yokohama Convention Facility, Yokohama, Japan from 25 October-4 November. One scientist from ICR participated in the meeting (Tamura). He presented the study titled 'Estimation of prey consumption by marine mammals in the PICES regions-Update to Hunt *et al.* (2000)' as an oral presentation at the session 'Diets, consumption, and abundance of marine birds and mammals in the North Pacific.' He was also co-author of another study titled 'Spatial estimation of prey consumption by Bryde's whales in the western North Pacific during the summers of 2008-2009: Density surface model approach,' that was also presented to the meeting.



Workpia Yokohama Convention Facility, Yokohama, Japan.

Annual meeting of the North Atlantic Marine Mammal Commission (NAMMCO) Scientific Committee (SC)

The North Atlantic Marine Mammal Commission (NAMMCO) is an international body for cooperation on the conservation, management and study of marine mammals in the North Atlantic. The NAMMCO Agreement was signed in Nuuk, Greenland on 9 April 1992 by Norway, Iceland, Greenland and the Faroe Islands, and entered into force 90 days later on 8 July 1992. The agreement focuses on modern approaches to the study of the marine ecosystem as a whole, and to better understanding the role of marine mammals in the ecosystem. NAMMCO has a Scientific Committee (SC) which meets annually.

The 2018 NAMMCO SC meeting was held on board the MS Polarlys, between Bergen and Tromsø, Norway from 13-16 November. Three scientists from ICR participated in the meeting (Pastene, Konishi and Takahashi) as observers from Japan. They presented the 2016-2018 Japan progress report on cetacean research as well a presentation on the whale's satellite tracking work by the ICR.



MS Polarlys, Norway.

National meetings

Participation of Scientists of the Institute of Cetacean Research in National Meetings in 2018

Annual meeting of the Japanese Society of Fisheries Science (JSFS)

The Japanese Society of Fisheries Science (JSFS) was established in 1932. It is a non-profit registered society dedicated to the promotion of all aspects of fisheries science. The society fulfills its global commitment by promoting science, striving to achieve sustainable development while recognizing crucial need of preserving the natural aquatic resources. It also strives to forego relationships with the industry comprising both capture and culture fisheries, the fishing environment, and the concerned trade. The main events organized by the society are the biannual meetings held in spring and autumn in one of the main cities of Japan. In this forum the members present their research activities, exchange information, and create partnerships in vital areas of research. Over 1,500 presentations are given during the meeting and a compendium of the abstracts is promptly published.

The 2018 spring meeting of the JSFS was held at the Tokyo University of Marine Science and Technology, Tokyo from 26 to 30 March, 2018. Three scientists from the Institute of Cetacean Research (ICR) participated in the meeting (Goto, Konishi and Isoda). Goto presented the study titled 'Estimation of stock structure and migratory pattern of common minke whales around Japanese waters' (co-authors Taguchi and Pastene). Konishi presented the study titled 'Tracking sei whales by satellite tags at the foraging area in the western North Pacific' (co-authors Isoda and Bando). Isoda presented the study titled 'Observation of marine debris in the Antarctic based on the Japanese Whale Research Program under Special Permit' (co-authors Tamura and Pastene). Other scientists from the ICR were co-authors in other presentations by scientists external to ICR, on topics related to estimation of abundance of sei whales (Matsuoka and Hakamada), and estimation of the feeding period of Antarctic minke whales in the Antarctic through stable isotope analyses (Tamura, Konishi and Bando).



Tokyo University of Marine Science and Technology, Tokyo.

The 2018 autumn meeting of JSFS was held at the School of Applied Biological Science, Hiroshima University, Hiroshima, from 15 to 18 September, 2018. Two scientists from the ICR participated as co-authors in presentations made to the meeting on topics related to population dynamics of sandlance in Sendai Bay (Tamura) and operating models for the North Pacific common minke whales (Goto).



Hiroshima University, Hiroshima.

Annual Meeting of the Mammal Society of Japan (MSJ)

The Mammal Society of Japan (MSJ) was established in 1987 by uniting two academic organizations, the Mammalogical Society of Japan and the Research Group of Mammalogists, which were founded in 1949 and 1955, respectively. The MSJ currently has an enrollment of over 1,100 members including students and non-professionals. The annual meeting of the society consists of academic sessions (symposia, oral presentations, and poster papers), workshops, and a business meeting.

The 2018 autumn meeting of MSJ was held at the

School of Applied Biological Science, Shinshu University, Nagano, from 7 to 10 September, 2018. Three scientists from the ICR participated as co-authors in presentations made to the meeting. The topics of the presentations were on abundance estimation of blue whales in the Antarctic (Matsuoka), estimation of spatial distribution of humpback whales in the North Pacific (Matsuoka), morphological comparison of finless porpoises (Kato) and skull variation among stocks of common minke whales in the western North Pacific (Fujise and Kato).



Shinshu University, Nagano.

Peer-reviewed publications

List of peer-reviewed publications based on the Institute of Cetacean Research (ICR)'s surveys up to 2018

This section presents a list of peer-reviewed publications based on data collected by surveys conducted under special scientific permit (JARPA/JARPAII and JARPN/JARPNII), including both lethal and non-lethal techniques. Peer-reviewed publications based on these surveys are focused mainly on topics related to assessment and management of large whales. However samples and data collected by the surveys have also been useful to carry out studies of a more academic-oriented nature. Publications based on such studies are also listed here.

This section also includes a list of peer-reviewed publications resulting from other surveys and research activities, different from special scientific permit surveys.

Publications having as a first author a non-ICR scientist commonly followed a data request or collaboration research agreement with ICR. In a few cases, external scientists used published data from ICR surveys in their analyses and publications, without a formal agreement with ICR. These cases are indicated by an asterisk (*).

JARPA/JARPAII surveys

1989 (2)

Kato, H., Hiroshima, H., Fujise, Y. and Ono, K. 1989. Preliminary report of the 1987/88 Japanese feasibility study of the special permit proposal for Southern Hemisphere minke whales. *Rep. int. Whal. Commn* 39: 235–248.

Nakamura, T., Ohnishi, S. and Matsumiya, Y. 1989. A Bayesian cohort model for catch-at-age data obtained from research takes of whales. *Rep. int. Whal. Commn* 39: 375–382.

1990 (8)

Butterworth, D.S. and Punt, A.E. 1990. Some preliminary examinations of the potential information content of age-structure data from Antarctic minke whale research catches. *Rep. int. Whal. Commn* 40: 301–315.

Ichii, T. 1990. Distribution of Antarctic krill concentrations exploited by Japanese krill trawlers and minke whales. *Proc. NIPR Symp. Polar Biol.* 3: 36–56.

Itoh, S., Takenaga, F. and Tsuyuki, H. 1990. Studies on lipids of the Antarctic minke whale. I. The fatty acid compositions of the minke whale blubber oils caught on 1987/88 season. *Yukagaku* 39 (7): 486–490 (in Japanese).

Kasamatsu, F., Kishino, H. and Hiroshima, H. 1990. Estimation of the number of minke whale (*Balaenoptera acutorostrata*) schools and individuals based on the 1987/88 Japanese feasibility study data. *Rep. int. Whal. Commn* 40: 239–247.

Kato, H., Fujise, Y., Yoshida, H., Nakagawa, S., Ishida, M. and Tanifuji, S. 1990. Cruise report and preliminary analysis of the 1988/89 Japanese feasibility study of the special permit proposal for southern hemisphere minke whales. *Rep. int. Whal. Commn* 40: 289–300.

Kato, H., Kishino, H. and Fujise, Y. 1990. Some analyses on age composition and segregation of southern minke whales using samples obtained by the Japanese feasibility study in 1987/88. *Rep. int. Whal. Commn* 40: 249–256.

Nagasaki, F. 1990. The Case for Scientific Whaling. *Nature* 334: 189–190.

Tanaka, S. 1990. Estimation of natural mortality coefficient of whales from the estimates of abundance and age composition data obtained from research catches. *Rep. int. Whal. Commn* 40: 531–536.

1991 (9)

Bergh, M.O., Butterworth, D.S. and Punt, A.E. 1991. Further examination of the potential information content of age-structure data from Antarctic minke whale research catches. *Rep. int. Whal. Commn* 41: 349–361.

Ichii, T. and Kato, H. 1991. Food and daily food consumption of southern minke whales in the Antarctic. *Polar Biol* 11 (7): 479–487.

Kasamatsu, F., Kishino, H. and Taga, Y. 1991. Estimation of southern minke whale abundance and school size composition based on the 1988/89 Japanese feasibility study data. *Rep. int. Whal. Commn* 41: 293–301.

Kato, H., Fujise, Y. and Kishino, H. 1991. Age structure and segregation of southern minke whales by the data obtained during Japanese research take in 1988/89. *Rep. int. Whal. Commn* 41: 287–292.

Kato, H. and Miyashita, T. 1991. Migration strategy of southern minke whales in relation to reproductive cycles estimated from foetal lengths. *Rep. int. Whal. Commn* 41: 363–369.

Kato, H., Zenitani, R. and Nakamura, T. 1991. Inter-reader calibration in age readings of earplugs from southern minke whale, with some notes of age readability. *Rep.*

int. Whal. Commn 41: 339–343.

Kishino, H., Kato, H., Kasamatsu, F. and Fujise, Y. 1991. Detection of heterogeneity and estimation of population characteristics from the field survey data: 1987/88 Japanese feasibility study of the Southern Hemisphere minke whales. *Ann. Inst. Statist. Math.* 43 (3): 435–453.

Nakamura, T. 1991. A new look at a Bayesian cohort model for time-series data obtained from research takes of whales. *Rep. int. Whal. Commn* 41: 345–348.

Wada, S., Kobayashi, T. and Numachi, K. 1991. Genetic variability and differentiation of mitochondrial DNA in minke whales. *Rep. int. Whal. Commn* (special issue 13): 203–215.

1992 (2)

Nakamura, T. 1992. Simulation trials of a Bayesian cohort model for time-series data obtained from research takes of whales. *Rep. int. Whal. Commn* 42: 421–427.

Tanaka, S., Kasamatsu, F. and Fujise, Y. 1992. Likely precision of estimates of natural mortality rates from Japanese research data for Southern Hemisphere minke whales. *Rep. int. Whal. Commn* 42: 413–420.

1993 (7)

Fujise, Y., Ishikawa, H., Saino, S., Nagano, M., Ishii, K., Kawaguchi, S., Tanifuji, S., Kawashima, S. and Miyakoshi H. 1993. Cruise report of the 1991/92 Japanese research in Area IV under the special permit for Southern Hemisphere minke whales. *Rep. int. Whal. Commn* 43: 357–371.

Hasunuma, R., Ogawa, T., Fujise, Y. and Kawanishi, Y. 1993. Analysis of selenium metabolites in urine samples of minke whale (*Balaenoptera acutorostrata*) using ion exchange chromatography. *Comp. Biochem. Physiol.* 104C (1): 87–89.

Itoh, S., Takenaga, F. and Tsuyuki, H. 1993. Studies on lipids of the Antarctic minke whale. II. The fatty acid compositions of the blubber oils of minke whale and dwarf minke whale caught on 1988/89 and 1989/90 seasons. *Yukagaku* 42 (12): 1007–1011 (in Japanese).

Iwata, H., Tanabe, S., Sakai, N. and Tatsukawa, R. 1993. Distribution of persistent organochlorines in the oceanic air and surface seawater and the role of ocean on their global transport and fate. *Environ. Sci. Technol.* 27: 1080–1098.

Kasamatsu, F., Yamamoto, Y., Zenitani, R., Ishikawa, H., Ishibashi, T., Sato, H., Takashima, K. and Tanifuji, S. 1993. Report of the 1990/91 southern minke whale research cruise under scientific permit in Area V. *Rep. int. Whal. Commn* 43: 505–522.

Nakamura, T. 1993. Two-stage Bayesian cohort model for time-series data to reduce bias in the estimate of mean natural mortality rate. *Rep. int. Whal. Commn* 43: 343–348.

Pastene, L.A., Kobayashi, T., Fujise, Y. and Numachi, K. 1993. Mitochondrial DNA differentiation in Antarctic minke whales. *Rep. int. Whal. Commn* 43: 349–355.

1994 (3)

Kimoto, H., Endo, Y. and Fujimoto, K. 1994. Influence of interesterification on the oxidative stability of marine oil triacylglycerols. *JAOCS* 71 (5): 469–473.

Pastene, L.A., Fujise, Y. and Numachi, K. 1994. Differentiation of mitochondrial DNA between ordinary and dwarf forms of southern minke whale. *Rep. int. Whal. Commn* 44: 277–281.

Yoshioka, M., Okumura, T., Aida, K. and Fujise, Y. 1994. A proposed technique for quantifying muscle progesterone content in the minke whales (*Balaenoptera acutorostrata*). *Can. J. Zoo.* 72: 368–370.

1995 (3)

Fukui, Y., Mogoe, T., Terawaki, Y., Ishikawa, H., Fujise, Y. and Ohsumi, S. 1995. Relationship between physiological status and serum constituent values in minke whales (*Balaenoptera acutorostrata*). *Journal of Reproduction and Development* 41 (3): 203–208.

Ishikawa, H. and Amasaki, H. 1995. Development and physiological degradation of tooth buds and development of rudiment of baleen plate in Southern minke whale, *Balaenoptera acutorostrata*. *J. Vet. Med. Sci.* 57 (4): 665–670.

Kasamatsu, F., Nishiwaki, S. and Ishikawa, H. 1995. Breeding areas and southbound migrations of southern minke whales *Balaenoptera acutorostrata*. *Mar. Ecol. Prog. Ser.* 119: 1–10.

1996 (7)

Bakke, I., Johansen, S., Bakke, O. and El-Gewely, M.R. 1996. Lack of population subdivision among the minke whales (*Balaenoptera acutorostrata*) from Icelandic and Norwegian waters based on mitochondrial DNA sequences. *Marine Biology* 125: 1–9.

Butterworth, D.S. and Geromont, H.F. 1996. On the provision of advice on the effect on stock(s) of scientific permit catches, with particular reference to proposed research catches of minke whales from Antarctic Area IV. *Rep. int. Whal. Commn* 46: 653–655.

Butterworth, D.S., Punt, A.E., Geromont, H.F., Kato, H. and Miyashita, T. 1996. An ADAPT approach to the analysis

- of catch-at-age information for Southern Hemisphere minke whales. *Rep. int. Whal. Commn* 46: 349–359.
- Fukui, Y., Mogoe, T., Jung, Y.G., Terawaki, Y., Miyamoto, A., Ishikawa, H., Fujise, Y. and Ohsumi, S. 1996. Relationships among morphological status, steroid hormones, and post-thawing viability of frozen spermatozoa of male minke whales (*Balaenoptera acutorostrata*). *Marine Mammal Science* 12 (1): 28–37.
- Iga, K., Fukui, Y., Miyamoto, A., Ishikawa, H. and Ohsumi, S. 1996. Endocrinological observations of female minke whales (*Balaenoptera acutorostrata*). *Marine Mammal Science* 12 (2): 296–301.
- Matsuoka, K., Fujise, Y. and Pastene, L.A. 1996. A sighting of a large school of the pygmy right whale, *Caperea marginata* in the southeast Indian Ocean. *Marine Mammal Science* 12 (4): 594–597.
- Pastene, L.A., Goto, M., Itoh, S. and Numachi, K. 1996. Spatial and temporal patterns of mitochondrial DNA variation in minke whale from Antarctic Areas IV and V. *Rep. int. Whal. Commn* 46: 305–314.
- 1997 (3)**
- Aono, S., Tanabe, S., Fujise, Y., Kato, H. and Tatsukawa, R. 1997. Persistent organochlorines in minke whale (*Balaenoptera acutorostrata*) and their prey species from the Antarctic and the North Pacific. *Environmental Pollution* 98: 81–89.
- Fukui, Y., Mogoe, T., Ishikawa, H. and Ohsumi, S. 1997a. Factors affecting *in vitro* maturation of minke whale (*Balaenoptera acutorostrata*) follicular oocytes. *Biology of Reproduction* 56: 523–528.
- Fukui, Y., Mogoe, T., Ishikawa, H. and Ohsumi, S. 1997b. *In vitro* fertilization of *in vitro* matured minke whale (*Balaenoptera acutorostrata*) follicular oocytes. *Marine Mammal Science* 13 (3): 395–404.
- 1998 (7)**
- Ichii, T., Shinohara, N., Fujise, Y., Nishiwaki, S. and Matsuoka, K. 1998. Interannual changes in body fat condition index of minke whales in the Antarctic. *Mar. Ecol. Prog. Ser.* 175: 1–12.
- Ito, S., Takenaga, F. and Tsuyuki, H. 1998. Lipids in Antarctic minke whales III. Site and sexual differences of muscle lipids. *J. Jpn. Oil Chem. Soc.* 47 (2): 191–194 (in Japanese).
- Kida, M.Y. 1998. Morphology of the tracheobronchial tree and the route of the pulmonary artery in the fetal minke whale (*Balaenoptera acutorostrata*). *Okajimas Folia Anat. Jpn.* 75 (5): 251–258.
- Mogoe, T., Fukui, Y., Ishikawa, H. and Ohsumi, S. 1998a. Morphological observations of frozen-thawed spermatozoa of Southern minke whales (*Balaenoptera acutorostrata*). *Journal of Reproduction and Development* 44 (1): 95–100.
- Mogoe, T., Fukui, Y., Ishikawa, H. and Ohsumi, S. 1998b. Effects of diluent composition and temperature on motility and viability after liquid storage and cryopreservation of minke whale (*Balaenoptera acutorostrata*) spermatozoa. *Marine Mammal Science* 14 (4): 854–860.
- Nagasawa, K., Yamada, T.K. and Ishikawa, H. 1998. Measurements of the skeleton of a minke whale (*Balaenoptera acutorostrata*) from the Antarctic Ocean. *Bulletin of the Yamagata Prefectural Museum* 20: 1–19.
- Terabayashi, T. and Kawanishi, Y. 1998. Naturally occurring ganglioside lactones in minke whale brain. *Carbohydrate Research* 307 (3): 281–290.
- 1999 (4)**
- Bannister, J.L., Pastene, L.A. and Burnell, S.R. 1999. First record of movement of a southern right whale (*Eubalaena australis*) between warm water breeding grounds and the Antarctic Ocean, South of 60°S. *Marine Mammal Science* 15 (4): 1337–1342.
- Butterworth, D.S., Punt, A.E., Geromont, H.F., Kato, H. and Fujise, Y. 1999. Inferences on the dynamics of Southern Hemisphere minke whales from ADAPT analyses of catch-at-age information. *J. Cetacean Res. Manage.* 1 (1): 11–32.
- Ishikawa, H., Amasaki, H., Dohguchi, H., Furuya, A. and Suzuki, K. 1999. Immunohistological distributions of fibronectin, tenascin, type I, III and IV collagens, and laminin during tooth development and degeneration in fetuses of minke whale, *Balaenoptera acutorostrata*. *J. Vet. Med. Sci.* 61 (3): 227–232.
- Thomson, R.B., Butterworth, D.S. and Kato, H. 1999. Has the age at transition of southern hemisphere minke whales declined over recent decades? *Marine Mammal Science* 15 (3): 661–682.
- 2000 (5)**
- Asada, M., Horii, M., Mogoe, T., Fukui, Y., Ishikawa, H. and Ohsumi, S. 2000. *In vitro* maturation and ultrastructural observation of cryopreserved minke whale (*Balaenoptera acutorostrata*) follicular oocytes. *Biology of Reproduction* 62 (2): 253–259.
- Kasamatsu, F., Matsuoka, K. and Hakamada, T. 2000. Interspecific relationships in density among the whale community in the Antarctic. *Polar Biol* 23 (7): 466–473.
- Mogoe, T., Suzuki, T., Asada, M., Fukui, Y., Ishikawa, H. and

Ohsumi, S. 2000. Functional reduction of the Southern minke whale (*Balaenoptera acutorostrata*) testis during the feeding season. *Marine Mammal Science* 16 (3): 559–569.

Rosenbaum, H.C., Brownell, R.L., Brown, M.W., Schaeff, C., Portway, V., White, B.N., Malik, S., Pastene, L.A., Pate-neude, N.J., Baker, C.S., Goto, M., Best, P.B., Clapham, P.J., Hamilton, P., Moore, M., Payne, R., Rowntree, V., Tynan, C.T., Bannister, J.L. and DeSalle, R. 2000. World-wide genetic differentiation of *Eubalaena*: questioning the number of right whale species. *Molecular Ecology* 9: 1793–1802.

Wei, H. and Fukui, Y. 2000. Fertilizability of ovine, bovine or minke whale (*Balaenoptera acutorostrata*) spermatozoa intracytoplasmically injected into bovine oocytes. *Zygote* 8 (3): 267–274.

2001 (3)

Asada, M., Tetsuka, M., Ishikawa, H., Ohsumi, S. and Fukui, Y. 2001. Improvement on *in vitro* maturation, fertilization and development of minke whale (*Balaenoptera acutorostrata*) oocytes. *Theriogenology* 56 (4): 521–533.

Asada, M., Wei, H., Nagayama, R., Tetsuka, M., Ishikawa, H., Ohsumi, S. and Fukui, Y. 2001. An attempt at intracytoplasmic sperm injection of frozen-thawed minke whale (*Balaenoptera bonaerensis*) oocytes. *Zygote* 9 (3): 299–307.

Suzuki, T., Mogoe, T., Asada, M., Miyamoto, A., Tetsuka, M., Ishikawa, H., Ohsumi, S. and Fukui, Y. 2001. Plasma and pituitary concentrations of gonadotropins (FSH and LH) in minke whales (*Balaenoptera acutorostrata*) during the feeding season. *Theriogenology* 55 (5): 1127–1141.

2002 (6)

Abe, H. and Goto, M. 2002. The application of microsatellite DNA for determining population structure of minke whale. pp. 109–113. In: Nishimura, A. (Ed). *Technical Reports of the Hokkaido National Fisheries Research Institute No.5*. Hokkaido National Fisheries Research Institute, Hokkaido.

Kunito, T., Watanabe, I., Yasunaga, G., Fujise, Y. and Tanabe, S. 2002. Using trace elements in skin to discriminate the populations of minke whale in southern hemisphere. *Marine Environmental Research* 53: 175–197.

Murase, H., Matsuoka, K., Ichii, T. and Nishiwaki, S. 2002. Relationship between the distribution of euphausiids and baleen whales in the Antarctic (35°E–145°W). *Polar Biol* 25 (2): 135–145.

Pastene, L.A., Goto, M. and Kanda, N. 2002. The utility of DNA analysis for the management and conservation of large whales. *Fish Sci* 68 (Supp. 1): 286–289.

Suzuki, M., Ishikawa, H., Otani, S., Tobayama, T., Katsumata, E., Ueda, K., Uchida, S., Yoshioka, M. and Aida, K. 2002. The characteristics of adrenal glands and its hormones in cetacean. *Fish Sci* 68 (Supp. 1): 272–275.

Urashima, T., Sato, H., Munakata, J., Nakamura, T., Arai, I., Saito, T., Tetsuka, M., Fukui, Y., Ishikawa, H., Lyndersen, C. and Kovacs, K.M. 2002. Chemical characterization of the oligosaccharides in beluga (*Delphinapterus leucas*) and minke whale (*Balaenoptera acutorostrata*) milk. *Comparative Biochemistry and Physiology Part B* 132: 611–624.

2003 (5)

Hayashi, K., Nishida, S., Yoshida, H., Goto, M., Pastene, L.A. and Koike, H. 2003. Sequence variation of the DQB allele in the cetacean MHC. *Mammal Study* 28 (2): 89–96.

Matsuoka, K., Watanabe, T., Ichii, T., Shimada, H. and Nishiwaki, S. 2003. Large whale distributions (south of 60°S, 35°E–130°E) in relation to the Southern Boundary of the Antarctic Circumpolar Current. pp. 26–30. In: *Antarctic Biology in a Global Context*. Proceedings of the VIIIth SCAR International Biology Symposium, 27 August–1 September 2001. Vrije Universiteit, Amsterdam, The Netherlands, Backhuys Publishers, Leiden.

Nishida, S., Hayashi, K., Pastene, L.A., Goto, M., Kanda, N. and Koike, H. 2003. Polymorphic analysis of cetacean MHC - A case study on the minke whales -. *Mammalian Science* 3: 75–78 (in Japanese).

Nishida, S., Pastene, L.A., Goto, M. and Kanda, N. 2003. SRY gene structure and phylogeny in the cetacean species. *Mammal Study* 28 (1): 57–66.

Ohishi, K., Zenitani, R., Bando, T., Goto, Y., Uchida, K., Maruyama, T., Yamamoto, S., Miyazaki, N. and Fujise, Y. 2003. Pathological and serological evidence of *Bruceella*-infection in baleen whales (Mysticeti) in the western North Pacific. *Comp. Immun. Microbiol. Infect. Dis.* 26 (2): 125–136.

2004 (8)

Amemiya, K., Iwanami, Y., Kobayashi, T., Terao, T., Fukui, Y., Ishikawa, H., Ohsumi, S., Hirabayashi, M. and Hochi, S. 2004. Acquirement of oocyte-activating factor in Antarctic minke whale (*Balaenoptera bonaerensis*) spermatogenic cells, assessed by meiosis resumption of microinseminated mouse oocytes. *J. Mamm. Ova Res.* 21: 149–156.

- Branch, T.A., Matsuoka, K. and Miyashita, T. 2004. Evidence for increase in Antarctic blue whales based on Bayesian modeling. *Marine Mammal Science* 20 (4):726–754.
- Fujihira, T., Kinoshita, M., Sasaki, M., Ohnishi, M., Ishikawa, H., Ohsumi, S. and Fukui, Y. 2004. Comparative studies on lipid analysis and ultrastructure in porcine and southern minke whale (*Balaenoptera bonaerensis*) oocytes. *Journal of Reproduction and Development* 50 (5): 525–532.
- Fukui, Y., Togawa, M., Abe, N., Takano, Y., Asada, M., Okada, A., Iida, K., Ishikawa, H. and Ohsumi, S. 2004. Validation of the sperm quality analyzer and the hypo-osmotic swelling test for frozen-thawed ram and minke whale (*Balaenoptera bonaerensis*) spermatozoa. *Journal of Reproduction and Development* 50 (1): 147–154.
- Ikumi, S., Sawai, K., Takeuchi, Y., Iwayama, H., Ishikawa, H., Ohsumi, S. and Fukui, Y. 2004. Interspecies somatic cell nuclear transfer for *in vitro* production of Antarctic minke Whale (*Balaenoptera bonaerensis*) Embryos. *Cloning and Stem Cells* 6 (3): 284–293.
- Iwayama, H., Hochi, S., Kato, M., Hirabayashi, M., Kuwayama, M., Ishikawa, H., Ohsumi, S. and Fukui, Y. 2004. Effects of cryodevice type and donor's sexual maturity on vitrification of minke whale (*Balaenoptera bonaerensis*) oocytes at germinal vesicle-stage. *Zygote* 12 (4): 333–338.
- Muranishi, Y., Sasaki, M., Hayashi, K., Abe, N., Fujihira, T., Ishikawa, H., Ohsumi, S., Miyamoto, A. and Fukui, Y. 2004. Relationship between the appearance of preantral follicles in the fetal ovary of Antarctic minke whales (*Balaenoptera bonaerensis*) and hormone concentrations in the fetal heart, umbilical cord and maternal blood. *Zygote* 12 (2): 125–132.
- Tetsuka, M., Asada, M., Mogoe, T., Fukui, Y., Ishikawa, H. and Ohsumi, S. 2004. The pattern of ovarian development in the prepubertal Antarctic minke whale (*Balaenoptera bonaerensis*). *Journal of Reproduction and Development* 50 (4): 381–389.
- 2005 (6)**
- Ishikawa, H. and Shigemune, H. 2005. Improvements in more humane killing methods of Antarctic minke whales, *Balaenoptera bonaerensis*, in the Japanese Whale Research Program under Special Permit in the Antarctic Sea (JARPA). *Jpn. J. Zoo Wildl. Med.* 10 (1): 27–34.
- Iwayama, H., Ishikawa, H., Ohsumi, S. and Fukui, Y. 2005. Attempt at *in vitro* maturation of minke whale (*Balaenoptera bonaerensis*) oocytes using a portable CO₂ incubator. *Journal of Reproduction and Development* 51 (1): 69–75.
- Matsuoka, K., Pitman, R. and Marques, F. 2005. A note on a pigmy right whale (*Caperea marginata*) sighting in the southwestern Pacific Ocean. *J. Cetacean Res. Manage.* 7(1): 71–73.
- Matsuoka, K., Hakamada, T., Kiwada, H., Murase, H. and Nishiwaki, S. 2005. Abundance increases of large baleen whales in the Antarctic based on the sighting survey during Japanese Whale Research Program (JARPA). *Global Environmental Research* 9 (2): 105–115.
- Nikaido, M., Sasaki, T., Makino, H., Goto, M., Kanda, N., Pastene, L.A. and Okada, N. 2005. Phylogenetic reconstruction of baleen whales and detection of their past extensive radiation event by the SINE insertion analysis. *Fossils* 77: 22–28 (in Japanese).
- Sasaki, T., Nikaido, M., Hamilton, H., Goto, M., Kato, H., Kanda, N., Pastene, L.A., Cao, Y., Fordyce, R.E., Hasegawa, M. and Okada, N. 2005. Mitochondrial phylogenetics and evolution of mysticete whales. *Systematic Biology* 54 (1): 77–90.
- 2006 (9)**
- Fujihira, T., Kobayashi, M., Hochi, S., Hirabayashi, M., Ishikawa, H., Ohsumi, S. and Fukui, Y. 2006. Developmental capacity of Antarctic minke whale (*Balaenoptera bonaerensis*) vitrified oocytes following *in vitro* maturation, and parthenogenetic activation or intracytoplasmic sperm injection. *Zygote* 14 (2): 89–95.
- Honda, K., Aoki, M. and Fujise, Y. 2006. Echochemical approach using mercury accumulation of Antarctic minke whale, *Balaenoptera bonaerensis*, as tracer of historical change of Antarctic marine ecosystem during 1980–1999. *Bull. Environ. Contam. Toxicol.* 76: 140–147.
- Iwanami, K., Mita, H., Yamamoto, Y., Fujise, Y., Yamada, T. and Suzuki, T. 2006. cDNA-derived amino acid sequences of myoglobins from nine species of whales and dolphins. *Comparative Biochemistry and Physiology, Part B* 145: 249–256.
- Kobayashi, T., Amemiya, K., Takeuchi, K., Tsujioka, T., Tominaga, K., Hirabayashi, M., Ishikawa, H., Fukui, Y. and Hochi, S. 2006. Contribution of spermatozoal centrosomes to the microtubule-organizing centre in Antarctic minke whale (*Balaenoptera bonaerensis*). *Zygote* 14 (1): 45–51.
- Konishi, K. 2006. Characteristics of blubber distribution and body condition indicators for Antarctic minke whale (*Balaenoptera bonaerensis*). *Mammal Study* 31 (1): 15–22.
- Mori, M. and Butterworth, D.S. 2006. A first step towards

modelling the krill–predator dynamics of the Antarctic ecosystem. *CCAMLR Science* 13: 217–277.

Nikaido, M., Hamilton, H., Makino, H., Sasaki, T., Takahashi, K., Goto, M., Kanda, N., Pastene, L.A. and Okada, N. 2006. Baleen whale phylogeny and a past extensive radiation event revealed by SINE insertion analysis. *Mol. Biol. Evol.* 23 (5): 866–873.

Rock, J., Pastene, L.A., Kaufman, G., Forestell, P., Matsuoka, K. and Allen, J. 2006. A note on East Australia Group V Stock humpback whale movement between feeding and breeding areas based on photo-identification. *J. Cetacean Res. Manage.* 8 (3): 301–305.

Yabuki, T., Suga, T., Hanawa, K., Matsuoka, K., Kiwada, H. and Watanabe, T. 2006. Possible source of the Antarctic bottom water in the Prydz Bay Region. *Journal of Oceanography* 62 (5): 649–655.

2007 (7)

Asada, M., Tetsuka, M., Ishikawa, H., Ohsumi, S. and Fukui, Y. 2007. Ultrastructural changes during maturation and cryopreservation of follicular oocytes of Antarctic minke whales (*Balaenoptera bonaerensis*). *Jpn. J. Zoo. Wildl. Med.* 12 (1): 51–66.

Branch, T.A., Stafford, K.M., Palacios, D.M., Allison, C., Bannister, J.L., Burton, C.L.K., Cabrera, E., Carlson, C.A., Galletti Vernazzani, B., Gill, P.C., Hucke-Gaete, R., Jenner, K.C.S., Jenner, Mn. M., Matsuoka, K., Mikhalev, Y.A., Miyashita, T., Morrice, M.G., Nishiwaki, S., Sturrock, V.J., Tormosov, D., Anderson, R.C., Baker, A.N., Best, P.B., Borsa, P., Brownell Jr, R.L., Childerhouse, S., Findlay, K.P., Gerrodette, T., Ilangakoon, A.D., Jørgensen, M., Kahn, B., Ljungblad, D.K., Maughan, B., Mccauley, R.D., Mckay, S., Norris, T.F., Oman Whale and Dolphin Research Group, Rankin, S., Samaran, F., Thiele, D., Van Waerebeek, K. and Warneke, R.M. 2007. Past and present distribution, densities and movements of blue whales in the Southern Hemisphere and adjacent waters. *Mammal Rev.* 37 (2): 116–175.

LeDuc, R.G., Dizon, A.E., Goto, M., Pastene, L.A., Kato, H., Nishiwaki, S. and Brownell, R.L. 2007. Patterns of genetic variation in southern hemisphere blue whales, and the use of assignment test to detect mixing on the feeding grounds. *J. Cetacean Res. Manage.* 9 (1): 73–80.

Nagai, H., Mogoe, T., Ishikawa, H., Hochi, S., Ohsumi, S. and Fukui, Y. 2007. Follicle size-dependent changes in follicular fluid components and oocyte diameter in Antarctic minke whales (*Balaenoptera bonaerensis*). *Journal of Reproduction and Development* 53 (6): 1265–1272.

Nishida, S., Goto, M., Pastene, L.A., Kanda, N. and Koike, H. 2007. Phylogenetic relationships among cetaceans revealed by Y-chromosome sequences. *Zoological Science* 24 (7): 723–732.

Onbe, K., Nishida, S., Sone, E., Kanda, N., Goto, M., Pastene, L.A., Tanabe, S. and Koike, H. 2007. Sequence variation in the *Tbx4* gene in marine mammals. *Zoological Science* 24 (5): 449–464.

Pastene, L.A., Goto, M., Kanda, N., Zerbini, A.N., Kerem, D., Watanabe, K., Bessho, Y., Hasegawa, M., Nielsen, R., Larsen, F. and Palsbøll, P.J. 2007. Radiation and speciation of pelagic organisms during periods of global warming: the case of the common minke whale, *Balaenoptera acutorostrata*. *Molecular Ecology* 16: 1481–1495.

2008 (4)

Ishikawa, H. and Shigemune, H. 2008. Comparative experiment of whaling grenades in the Japanese Whale Research Program under Special Permit (JARPA and JARPN). *Jpn. J. Zoo Wildl. Med.* 13 (1): 21–28.

Konishi, K., Tamura, T., Zenitani, R., Bando, T., Kato, H. and Walløe, L. 2008. Decline in energy storage in the Antarctic minke whale (*Balaenoptera bonaerensis*) in the Southern Ocean. *Polar Biol* 31 (2): 1509–1520.

Ohishi, K., Fujise, Y. and Maruyama, T. 2008. *Brucella* spp. in the western North Pacific and Antarctic cetaceans: a review. *J. Cetacean Res. Manage.* 10 (1): 67–72.

Yunoki, K., Ishikawa, H., Fukui, Y. and Ohnishi, M. 2008. Chemical properties of epidermal lipids, especially sphingolipids, of the Antarctic minke whale. *Lipids* 43 (2): 151–159.

2009 (2)

Ono, N., Yamaguchi, T., Ishikawa, H., Arakawa, M., Takahashi, N., Saikawa, T. and Shimada, T. 2009. Morphological varieties of the Purkinje fiber network in mammalian hearts, as revealed by light and electron microscopy. *Arch Histol Cytol* 72 (3): 139–149.

Tamura, T. and Konishi, K. 2009. Feeding habits and prey consumption of Antarctic minke whale (*Balaenoptera bonaerensis*) in the Southern Ocean. *J. Northw. Atl. Fish. Sci.* 42: 13–25.

2010 (15)

Fujise, Y., Nishiwaki, S. and Ishikawa, S. 2010. Overview of the Japanese Whale Research Program under Special Permit in the Antarctic (JARPA). *Bull. Jpn. Soc. Fish. Oceanogr.* 74: 43–44 (in Japanese).

Fujise, Y., Hatanaka, H. and Ohsumi, S. 2010. Changes

- in the Antarctic marine ecosystem as revealed by the JARPA research: What has happened to the Antarctic minke whale stocks? *Ottar* (Tromsø Museum) 280: 29–34 (in Norwegian).
- Glover, K.A., Kanda, N., Haug, T., Pastene, L.A., Øien, N., Goto, M., Seliussen, B.B. and Skaug, H.J. Migration of Antarctic minke whales to the Arctic. *PLoS ONE* 5 (12): e15197.
- Ishikawa, H. 2010. Animal Welfare - Introduction -. *Jpn. J. Zoo. Wildl. Med.* 15 (1): 1–3 (in Japanese).
- Ishikawa, H. 2010. Lethal Research for Wildlife. *Jpn. J. Zoo. Wildl. Med.* 15 (1): 9–14 (in Japanese).
- Kokubun, N., Yasuma, H., Murase, H. and Naganobu, M. 2010. Distribution of seabirds in the Ross Sea, Antarctica. *Bull. Jpn. Soc. Fish. Oceanogr.* 74: 42–43 (in Japanese).
- Matsuoka, K., Kiwada, K., Murase, H. and Nishiwaki, S. 2010. Whale species composition and their distribution patterns in the Ross Sea, Antarctica. *Bull. Jpn. Soc. Fish. Oceanogr.* 74: 44–45 (in Japanese).
- Murase, H., Matsuoka, K., Hakamada, T., Nishiwaki, S., Naganobu, M. and Kitakado, T. 2010. Estimation of spatial distribution pattern of cetacean using environmental covariates in the Ross Sea, Antarctica. *Bull. Jpn. Soc. Fish. Oceanogr.* 74: 47–48 (in Japanese).
- Naganobu, M. and Murase, H. 2010. Ecological linkage between oceanographic environment and distribution of top predators and their preys in the Ross Sea region. *Bull. Jpn. Soc. Fish. Oceanogr.* 74: 48–49 (in Japanese).
- Naganobu, M., Murase, H., Nishiwaki, S., Yasuma, H., Matsukura, R., Takao, Y., Taki, K., Hayashi, T., Watanabe, Y., Yabuki, T., Yoda, Y., Noiri, Y., Kuga, M., Yoshikawa, K., Kokubun, N., Iwami, T., K., Itoh, K., Goto, M., Isoda, T., Matsuoka, K., Tamura, T. and Fujise, Y. 2010. Structure of marine ecosystem of the Ross Sea, Antarctica—overview and synthesis of the results of the Japanese multidisciplinary study by *Kaiyo-Maru* and JARPA—. *Bull. Jpn. Soc. Fish. Oceanogr.* 74: 1–12.
- Naganobu, M., Nishiwaki, S., Nagai, N. and Tohyama, D. 2010. Multidisciplinary ecological survey by the R/V *Kaiyo Maru* and JARPA in the Ross Sea, Antarctica. *Bull. Jpn. Soc. Fish. Oceanogr.* 74: 34–35 (in Japanese).
- Pastene, L. A., Acevedo, J., Goto, M., Zerbini, A.N., Acuna, P. and Aguayo-Lobo, A. 2010. Population structure and possible migratory links of common minke whales, *Balaenoptera acutorostrata*, in the Southern Hemisphere. *Conserv Genet* 11 (4): 1553–1558.
- Tamura, T., Konishi, K., Nishiwaki, S., Taki, K., Hayashi, T. and Naganobu, M. 2010. Feeding ecology of the Antarctic minke whales in the Ross Sea, Antarctica. *Bull. Jpn. Soc. Fish. Oceanogr.* 74: 46–47 (in Japanese).
- Yabuki, T., Noiri, Y., Murase, H., Kiwada, H., Matsuoka, K. and Naganobu, M. 2010. Physical and chemical study of hydrographic feature based on the R/V *Kaiyo Maru* cruise and JARPA in the Ross Sea, Antarctica. *Bull. Jpn. Soc. Fish. Oceanogr.* 74: 35–36 (in Japanese).
- Zenitani, R. and Kato, H. 2010. The growth of baleen plates in Antarctic minke whales, with special reference to the V-shape notch appearing at the outer edge of the plates. *Nippon Suisan Gakkaishi* 76 (5): 870–876 (in Japanese with English abstract).
- 2011 (1)**
- Matsuoka, K., Hakamada, T., Kiwada, H., Murase, H. and Nishiwaki, S. 2011. Abundance estimates and trends for humpback whales (*Megaptera novaeangliae*) in Antarctic Areas IV and V based on JARPA sighting data. *J. Cetacean Res. Manage.* (Special Issue 3): 75–94.
- 2012 (1)**
- *Sremba, A.L., Hancock-Hanser, B., Branch, T.A., LeDuc, R.L. and Baker, C.S. 2012. Circumpolar diversity and geographic differentiation of mtDNA in the critically endangered Antarctic blue whale (*Balaenoptera musculus intermedia*). *PLoS ONE* 7 (3): e32579.
- 2013 (6)**
- Glover, K.A., Kanda, N., Haug, T., Pastene, L.A., Øien, N., Seliussen, B.B., Sørvik, A.G.E. and Skaug, H.J. 2013. Hybrids between common and Antarctic minke whales are fertile and can back-cross. *BMC Genetics* 14: 25.
- Hakamada, T., Matsuoka, K., Nishiwaki, S. and Kitakado, T. 2013. Abundance estimates and trends for Antarctic minke whales (*Balaenoptera bonaerensis*) in Antarctic Areas IV and V for the period 1989/90–2004/05. *J. Cetacean Res. Manage.* 13 (2): 123–151.
- Kitakado, T., Lockyer, C. and Punt, A.E. 2013. A statistical model for quantifying age-reading errors and its application to the Antarctic minke whales. *J. Cetacean Res. Manage.* 13 (3): 181–190.
- Murase, H., Kitakado, T., Hakamada, T., Matsuoka, K., Nishiwaki, S. and Naganobu, M. 2013. Spatial distribution of Antarctic minke whales (*Balaenoptera bonaerensis*) in relation to spatial distributions of krill in the Ross Sea, Antarctica. *Fish. Oceanogr.* 22 (3): 154–173.
- Sasaki, M., Amano, Y., Hayakawa, D., Tsubota, T., Ishikawa, H., Mogoe, T., Ohsumi, S., Tetsuka, M., Miyamoto, A., Fukui, Y., Budipitojo, T. and Kitamura, N. 2013. Structure and steroidogenesis of the placenta in the Antarctic minke whale (*Balaenoptera bonaerensis*). *Journal of*

Reproduction and Development 59 (2): 159–167.

Shibata, Y., Matsuishi, T., Murase, H., Matsuoka, K., Hakamada, T., Kitakado, T. and Matsuda, H. 2013. Effects of stratification and misspecification of covariates on species distribution models for abundance estimation from virtual line transect survey data. *Fish Sci* 79 (4): 559–568.

2014 (3)

Konishi, K., Hakamada, T., Kiwada, H., Kitakado, T. and Walløe, L. 2014. Decrease in stomach contents in the Antarctic minke whale (*Balaenoptera bonaerensis*) in the Southern Ocean. *Polar Biol* 37 (2): 205–215.

Punt, A.E. 2014. A summary history of the application of statistical catch-at-age analysis (SCAA) to Antarctic minke whales. *J. Cetacean Res. Manage.* 14: 81–92.

Punt, A.E., Hakamada, T., Bando, T. and Kitakado, T. 2014. Assessment of Antarctic minke whales using statistical catch-at-age analysis (SCAA). *J. Cetacean Res. Manage.* 14: 93–116.

2015 (2)

Konishi, K. and Walløe, L. 2015. Substantial decline in energy storage and stomach fullness in Antarctic minke whales (*Balaenoptera bonaerensis*) during the 1990's. *J. Cetacean Res. Manage.* 15: 77–92.

Yasunaga, G., Fujise, Y., Zenitani, R., Tanabe, S. and Kato, H. 2015. Spatial and temporal variation of PCBs and organochlorine pesticides in the Antarctic minke whales, *Balaenoptera bonaerensis*, in the period 1987–2005. *Chemosphere* 126: 11–17.

2016 (2)

Pastene, L.A. and Goto, M. 2016. Genetic characterization and population genetic structure of the Antarctic minke whale *Balaenoptera bonaerensis* in the Indo-Pacific region of the Southern Ocean. *Fish Sci* 82 (6): 873–886.

Wada, N., Yamanaka, S., Shibato, J., Rakwal, R., Hirako, S., Iizuka, Y., Kim, H., Matsumoto, A., Kimura, A., Takenoya, F., Yasunaga, G. and Shioda, S. 2016. Behavioral and omics analyses study on potential involvement of dipeptide balenine through supplementation in diet of senescence-accelerated mouse prone 8. *Genomics Data* 10: 38–50.

2017 (3)

Isoda, T. and Tamura, T. 2017. Report of a White Adélie Penguin *Pygoscelis adeliae* in the Antarctic Ocean. *J. Yamashina Inst. Ornithol.* 48 (2): 74–77.

*Leduc, R.G., Archer, F.I., Lang, A.R., Martien, K.K., Hancock-Hanser, B., Torres-Florez, J.P., Hucke-Gaete, R., Rosenbaum, H.C., VanWaerebeek, Bownell, R.L. and Taylor, B.L. 2017. Genetic variation in blue whales in the eastern pacific: implications for taxonomy and use of common wintering grounds. *Molecular Ecology* 26: 740–751.

Yasunaga, G., Pastene, L.A., Bando, T., Hakamada, T. and Fujise, Y. 2017. Age estimation of Antarctic minke whales *Balaenoptera bonaerensis* based on aspartic acid racemization technique. *Fish Sci* 86 (6): 947–954.

JARPN/JARPNII surveys

1996 (3)

Butterworth, D.S., Geromont H.F. and Wada S. 1996. Further analysis of allele frequency data to provide estimates of the extent of mixing between the various North Pacific minke whale stocks, and their implications for the status of the "O" stock. *Rep. int. Whal. Commn* 46: 443–451.

Kuramochi, T., Machida, M., Araki, J., Uchida, A., Kishiro, T. and Nagasawa, K. 1996. Minke whales (*Balaenoptera acutorostrata*) are one of the major final hosts of *Anisakis simplex* (Nematoda: Anisakidae) in the North-western North Pacific Ocean. *Rep. int. Whal. Commn* 46: 415–419.

Miyashita, T. and Fujise, Y. 1996. Abundance estimate of the western North Pacific minke whale in sub-area 9 with notes on the results of dedicated surveys. *Rep. int. Whal. Commn* 47: 543–551.

1997 (6)

Aono, S., Tanabe, S., Fujise, Y., Kato, H. and Tatsukawa, R. 1997. Persistent organochlorines in minke whale (*Balaenoptera acutorostrata*) and their prey species from the Antarctic and the North Pacific. *Environmental Pollution* 98: 81–89.

Araki, J., Kuramochi, T., Machida, M., Nagasawa, K. and Uchida, A. 1997. A note on the parasite fauna of the western North Pacific minke whale (*Balaenoptera acutorostrata*). *Rep. int. Whal. Commn* 47: 565–567.

Goto, M. and Pastene, L.A. 1997. Population structure of western North Pacific minke whale based on an RFLP analysis of mtDNA control region. *Rep. int. Whal. Commn* 47: 531–537.

Hatanaka, H. and Miyashita, T. 1997. On the feeding migration of the Okhotsk Sea-West Pacific stock of minke whales, estimates based on length composition data. *Rep. int. Whal. Commn* 47: 557–564.

Hatanaka, H. 1997. A short review of hypotheses on

minke whale stock structure in the Northwestern part of the North Pacific. *Rep. int. Whal. Commn* 47: 553–555.

Pastene, L.A., Goto, M., Itoh, S., Wada, S. and Kato, H. 1997. Intra- and inter-oceanic patterns of mitochondrial DNA variation in the Bryde's whale, *Balaenoptera edeni*. *Rep. int. Whal. Commn* 47: 569–574.

1998 (4)

Lindstrøm, U., Fujise, Y., Haug, T. and Tamura, T. 1998. Feeding habits of western North Pacific minke whales, *Balaenoptera acutorostrata*, as observed in July–September 1996. *Rep. int. Whal. Commn* 48: 463–469.

Pastene, L.A., Goto, M. and Kishino, H. 1998. An estimate of mixing proportion of 'J' and 'O' stocks minke whales in sub-area 11 based on mitochondrial DNA haplotype data. *Rep. int. Whal. Commn* 48: 471–474.

Tamura, T., Fujise, Y. and Shimazaki, K. 1998. Diet of minke whales *Balaenoptera acutorostrata* in the Northwestern part of the North Pacific in summer 1994 and 1995. *Fish Sci* 64 (1): 71–76.

Uchida, A., Kawakami, Y., Yuzu, S., Kishikawa, S., Kuramochi, T., Araki, J., Machida, M. and Nagasawa, K. 1998. Prevalence of parasites and histopathology of parasitisation in minke whales (*Balaenoptera acutorostrata*) from the western North Pacific Ocean and Southern Sea of Okhotsk. *Rep. int. Whal. Commn* 48: 475–479.

1999 (2)

Le, T.H.L., Takahashi, S., Saeki, K., Nakatani, N., Tanabe, S., Miyazaki, N. and Fujise, Y. 1999. High percentage of butyltin residues in total tin in the livers of cetaceans from Japanese coastal waters. *Environmental Science & Technology* 33 (11): 1781–1786.

Martinez, I. and Pastene, L.A. 1999. RAPD-typing of central and eastern North Atlantic and western North Pacific minke whales, *Balaenoptera acutorostrata*. *ICES Journal of Marine Science* 56 (5): 640–651.

2000 (2)

Punt, A.E., Butterworth, D.S. and Wada, S. 2000. On the use of allele frequency data within a Bayesian framework: evaluation of relative probabilities of alternative stock structure hypotheses for North Pacific minke whales. *J. Cetacean Res. Manage.* 2 (2): 151–158.

Uchida, A. and Araki, J. 2000. The ectoparasites and endoparasites in the minke whale, *Balaenoptera acutorostrata* from the western North Pacific Ocean. *J. Jpn. Vet. Med. Assoc.* 53 (2): 85–88 (in Japanese).

2001 (1)

Okamura, H., Matsuoka, K., Hakamada, T., Okazaki, M. and Miyashita, T. 2001. Spatial and temporal structure of the western North Pacific minke whale distribution inferred from JARPN sightings data. *J. Cetacean Res. Manage.* 3 (2): 193–200.

2002 (5)

Abe, H. and Goto, M. 2002. The application of microsatellite DNA for determining population structure of minke whale. pp. 109–113. In: Nishimura, A. (Ed). *Technical Reports of the Hokkaido National Fisheries Research Institute No.5*. Hokkaido National Fisheries Research Institute, Hokkaido.

Cui, G., Punt, A.E., Pastene, L. A. and Goto, M. 2002. Bayes and Empirical Bayes approaches to addressing stock structure questions using mtDNA data, with an illustrative application to North Pacific minke whales. *J. Cetacean Res. Manage.* 4 (2): 123–134.

Ohsumi, S. and Tamura, T. 2002. Dietary studies on baleen whales in the North Pacific. *Fish Sci* 68 (Supp. 1): 260–263.

Pastene, L.A., Goto, M. and Kanda, N. 2002. The utility of DNA analysis for the management and conservation of large whales. *Fish Sci* 68 (Supp. 1): 286–289.

Tamura T. and Fujise Y. 2002. Geographical and seasonal changes of the prey species of minke whale in the Northwestern Pacific. *ICES Journal of Marine Science* 59 (3): 516–528.

2003 (4)

Hayashi, K., Nishida, S., Yoshida, H., Goto, M., Pastene, L.A. and Koike, H. 2003. Sequence variation of the *DQB* allele in the cetacean MHC. *Mammal Study* 28 (2): 89–96.

Nishida, S., Pastene, L.A., Goto, M. and Kanda, N. 2003. *SRY* gene structure and phylogeny in the cetacean species. *Mammal Study* 28 (1): 57–66.

Nishida, S., Hayashi, K., Pastene, L.A., Goto, M., Kanda, N. and Koike, H. 2003. Polymorphic analysis of cetacean MHC - A case study on the minke whales -. *Mammalian Science* 3: 75–78 (in Japanese).

Ohishi, K., Zenitani, R., Bando, T., Goto, Y., Uchida, K., Maruyama, T., Yamamoto, S., Miyazaki, N. and Fujise, Y. 2003. Pathological and serological evidence of Brucella-infection in baleen whales (Mysticeti) in the western North Pacific. *Comp. Immun. Microbiol. Infect. Dis* 26 (2): 125–136.

2004 (5)

- Kim, E.Y., Iwata, H., Fujise, Y. and Tanabe, S. 2004. Searching for novel CYP members using cDNA library from a minke whale liver. *Marine Environmental Research* 58: 495–498.
- Ohishi, K., Takishita, K., Kawato, M., Zenitani, R., Bando, T., Fujise, Y., Goto, Y., Yamamoto, S. and Maruyama, T. 2004. Molecular evidence of new variant *Brucella* in North Pacific common minke whales. *Microbes and Infection* 6: 1199–1204.
- Ohishi, K., Takishita, K., Kawato, M., Maruyama, T., Zenitani, R., Bando, T., Fujise, Y., Goto, Y. and Yamamoto, S. 2004. Molecular characterization of *Brucella* from North Pacific common minke whale. *Oceans'04*: 499–504.
- Watanabe, H., Mogoe, T., Asada, M., Hayashi, K., Fujise, Y., Ishikawa, H., Ohsumi, S., Miyamoto, A. and Fukui, Y. 2004. Relationship between serum sex hormone concentrations and histology of seminiferous tubules of captured baleen whales in the western North Pacific during the feeding season. *Journal of Reproduction and Development* 50 (4): 419–427.
- Zharikov, K., Fujise, Y., Tamura, T., Kiwada, H., Bando, T., Konishi, K. and Isoda, T. 2004. Distribution and feeding of large cetaceans based on the data of JARPN II - 2003 May, 17-July, 9. *Marine Mammals of the Holarctic* 2004: 207–210.

2005 (5)

- Birukawa, N., Ando, H., Goto, M., Kanda, N., Pastene, L.A., Nakatsuji, H., Hata, H. and Urano, A. 2005. Plasma and urine levels of electrolytes, urea and steroid hormones involved in osmoregulation of cetaceans. *Zoological Science* 22 (11): 1245–1257.
- Nikaido, M., Sasaki, T., Makino, H., Goto, M., Kanda, N., Pastene, L.A. and Okada, N. 2005. Phylogenetic reconstruction of baleen whales and detection of their past extensive radiation event by the SINE insertion analysis. *Fossils* 77: 22–28 (in Japanese).
- Niimi, S., Watanabe, M.X., Kim, E.Y., Iwata, H., Yasunaga, G., Fujise, Y. and Tanabe, S. 2005. Molecular cloning and mRNA expression of cytochrome P4501A1 and 1A2 in the liver of common minke whales (*Balaenoptera acutorostrata*). *Marine Pollution Bulletin* 51 (8): 784–793.
- Ohishi, K., Takishita, K., Kawato, M., Zenitani, R., Bando, T., Fujise, Y., Goto, Y., Yamamoto, S. and Maruyama, T. 2005. Chimeric structure of *omp2* of *Brucella* from North Pacific common minke whales (*Balaenoptera acutorostrata*). *Microbiol. Immunol.* 49 (8): 789–793.

- Sasaki, T., Nikaido, M., Hamilton, H., Goto, M., Kato, H., Kanda, N., Pastene, L.A., Cao, Y., Fordyce, R.E., Hasegawa, M. and Okada, N. 2005. Mitochondrial phylogenetics and evolution of mysticete whales. *Systematic Biology* 54 (1): 77–90.

2006 (5)

- Iwanami, K., Mita, H., Yamamoto, Y., Fujise, Y., Yamada, T. and Suzuki, T. 2006. cDNA-derived amino acid sequences of myoglobins from nine species of whales and dolphins. *Comparative Biochemistry and Physiology, Part B* 145: 249–256.
- Kanda, N., Goto, M. and Pastene, L. A. 2006. Genetic characteristics of western North Pacific sei whales, *Balaenoptera borealis*, as revealed by microsatellites. *Marine Biotechnology* 8: 86–93.
- Mitani, Y., Bando, T., Takai, N. and Sakamoto, W. 2006. Patterns of stable carbon and nitrogen isotopes in the baleens of common minke whale *Balaenoptera acutorostrata* from the western North Pacific. *Fish Sci* 72 (1): 69–76.
- Nikaido, M., Hamilton, H., Makino, H., Sasaki, T., Takahashi, K., Goto, M., Kanda, N., Pastene, L.A. and Okada, N. 2006. Baleen whale phylogeny and a past extensive radiation event revealed by SINE insertion analysis. *Molecular Biology and Evolution* 23 (5): 866–873.
- Ohishi, K., Maruyama, T., Ninomiya, A., Kida, H., Zenitani, R., Bando, T., Fujise, Y., Nakamatsu, K., Miyazaki, N. and Boltunov, A.N. 2006. Serologic investigation of influenza A virus infection in cetaceans from the western North Pacific and the Southern Oceans. *Marine Mammal Science* 22 (1): 214–221.

2007 (11)

- Fukui, Y., Iwayama, H., Matsuoka, T., Nagai, H., Koma, N., Mogoe, T., Ishikawa, H., Fujise, Y., Hirabayashi, M., Hochi, S., Kato, H. and Ohsumi, S. 2007. Attempt at intracytoplasmic sperm injection of *in vitro* matured oocytes in common minke whales (*Balaenoptera acutorostrata*) captured during the Kushiro coast survey. *Journal of Reproduction and Development*. 53 (4): 945–952.
- Kanda, N., Goto, M., Kato, H., McPhee, M.V. and Pastene, L.A. 2007. Population genetic structure of Bryde's whales (*Balaenoptera brydei*) at the inter-oceanic and trans-equatorial levels. *Conservation Genetics* 8 (4): 853–864.
- Konishi, K. and Tamura, T. 2007. Occurrence of the minimal armhook squids *Berryteuthis anonychus* (Cephalopoda: Gonatidae) in the stomachs of common minke

- whales *Balaenoptera acutorostrata* in the western North Pacific. *Fish Sci* 73 (5): 1208–1210.
- Murase, H., Tamura, T., Kiwada, H., Fujise, Y., Watanabe, H., Ohizumi, H., Yonezaki, S., Okamura, H. and Kawahara, S. 2007. Prey selection of common minke (*Balaenoptera acutorostrata*) and Bryde's (*Balaenoptera edeni*) whales in the western North Pacific in 2000 and 2001. *Fish. Oceanogr.* 16 (2): 186–201.
- Niimi, S., Kim, E.Y., Iwata, H., Watanabe, M.X., Yasunaga, G., Fujise, Y. and Tanabe, S. 2007. Identification and hepatic expression profiles of cytochrome P450 1–4 isozymes in common minke whales (*Balaenoptera acutorostrata*). *Comparative Biochemistry and Physiology, Part B* 147: 667–681.
- Nishida, S., Goto, M., Pastene, L.A., Kanda, N. and Koike, H. 2007. Phylogenetic relationships among cetaceans revealed by Y-chromosome sequences. *Zoological Science* 24 (7): 723–732.
- Onbe, K., Nishida, S., Sone, E., Kanda, N., Goto, M., Pastene, L.A., Tanabe, S. and Koike, H. 2007. Sequence variation in the Tbx4 Gene in marine mammals. *Zoological Science* 24 (5): 449–464.
- Pastene, L.A., Goto, M., Kanda, N., Zerbini, A.N., Kerem, D., Watanabe, K., Bessho, Y., Hasegawa, M., Nielsen, R., Larsen, F. and Palsbøll, P.J. 2007. Radiation and speciation of pelagic organisms during periods of global warming: the case of the common minke whale, *Balaenoptera acutorostrata*. *Molecular Ecology* 16: 1481–1495.
- Urashima, T., Kobayashi, M., Asakuma, S., Uemura, Y., Arai, I., Fukuda, K., Saito, T., Mogoe, T., Ishikawa, H. and Fukui, Y. 2007. Chemical characterization of the oligosaccharides in Bryde's whale (*Balaenoptera edeni*) and Sei whale (*Balaenoptera borealis*) milk. *Comparative Biochemistry and Physiology, Part B* 146: 153–159.
- Watanabe, H., Tateno, H., Kusakabe, H., Kamiguchi, Y., Fujise, Y., Ishikawa, H., Ohsumi, S. and Fukui, Y. 2007. Fertilizability and chromosomal integrity of frozen-thawed Bryde's whale (*Balaenoptera edeni*) spermatozoa intracytoplasmically injected into mouse oocytes. *Reproduction, Fertility and Development* 19 (1): 306.
- Watanabe, H., Tateno, H., Kusakabe, H., Matsuoka, T., Kamiguchi, Y., Fujise, Y., Ishikawa, H., Ohsumi, S. and Fukui, Y. 2007. Fertilizability and chromosomal integrity of frozen-thawed Bryde's whale (*Balaenoptera edeni*) spermatozoa intracytoplasmically injected into mouse oocytes. *Zygote* 15 (1): 9–14.
- 2008 (3)**
- Birukawa, N., Ando, H., Goto, M., Kanda, N., Pastene, L.A. and Urano, A. 2008. Molecular cloning of urea transporters from the kidneys of baleen and toothed whales. *Comparative Biochemistry and Physiology, Part B* 149: 227–235.
- Ishikawa, H. and Shigemune, H. 2008. Comparative experiment of whaling grenades in the Japanese Whale Research Program under Special Permit (JARPA and JARPN). *Jpn. J. Zoo Wildl. Med.* 13 (1): 21–28.
- Ohishi, K., Fujise, Y. and Maruyama, T. 2008. *Brucella* spp. in the western North Pacific and Antarctic cetaceans: a review. *J. Cetacean Res. Manage.* 10 (1): 67–72.
- 2009 (9)**
- Bhuiyan, M.M.U., Suzuki, Y., Watanabe, H., Hirayama, H., Matsuoka, K., Fujise, Y., Ishikawa, H., Ohsumi, S. and Fukui, Y. 2009. Attempts at in vitro fertilization and culture of in vitro matured oocytes in sei (*Balaenoptera borealis*) and Bryde's (*B. edeni*) whales. *Zygote* 17 (1): 19–28.
- Fujita, H., Honda, K., Hamada, N., Yasunaga, G. and Fujise, Y. 2009. Validation of high-throughput measurement system with microwave-assisted extraction, fully automated sample preparation device, and gas chromatography-electron capture detector for determination of polychlorinated biphenyls in whale blubber. *Chemosphere* 74: 1069–1078.
- Hiwasa, M., Suzuki, Y., Watanabe, H., Bhuiyan, M.M.U., Matsuoka, K., Fujise, Y., Ishikawa, H., Ohsumi, S. and Fukui, Y. 2009. Effects of semen extenders and storage temperatures on characteristics of frozen-thawed Bryde's (*Balaenoptera edeni*) whale spermatozoa. *Journal of Reproduction and Development* 55: 599–606.
- Konishi, K., Tamura, T., Isoda, T., Okamoto, R., Hakamada, T., Kiwada, H. and Matsuoka, K. 2009. Feeding strategies and prey consumption of three baleen whale species within the Kushiro-Current Extension. *J. Northw. Atl. Fish. Sci.* 42: 27–40.
- Lee, E., Bhuiyan, M.M.U., Watanabe, H., Matsuoka, K., Fujise, Y., Ishikawa, H. and Fukui, Y. 2009. Production of cloned sei whale (*Balaenoptera borealis*) embryos by interspecies somatic cell nuclear transfer using enucleated pig oocytes. *J. Vet. Sci.* 10 (4): 285–292.
- Matsukura, R., Yasuma, H., Murase, H., Yonezaki, S., Funamoto, T., Honda, S. and Miyashita, K. 2009. Measurements of density contrast and sound-speed contrast for target strength estimation of Neocalanus copepods (*Neocalanus cristatus*) in the North Pacific Ocean. *Fish Sci* 75 (6): 1377–1387.
- Murase, H., Ichihara, M., Yasuma, H., Watanabe, H., Yonezaki, S., Nagashima, H., Kawahara, S. and Miyashita, T.

2009. Acoustic characterization of biological backscatterings in the Kuroshio-Oyashio inter-frontal zone and subarctic waters of the western North Pacific in spring. *Fish. Oceanogr.* 18 (6): 386–401.

Murase, H., Nagashima, H., Yonezaki, S., Matsukura, R. and Kitakado, T. 2009. Application of a generalized additive model (GAM) to reveal relationships between environmental factors and distributions of pelagic fish and krill: a case study in Sendai Bay, Japan. *ICES Journal of Marine Science* 66 (6): 1417–1424.

Tsuki, K., Sato, A., Kaneko, H., Yasunaga, G., Fujise, Y. and Nomata, H. 2009. Comparison of physiologically significant imidazole dipeptides in cetaceans sampled in Japanese whale research (short paper). *Sci. Rep. Hokkaido Fish. Exp. Stn.* 74: 25–28 (in Japanese).

2010 (7)

Bhuiyan, M.M.U., Suzuki, Y., Watanabe, H., Lee, E., Hirayama, H., Matsuoka, K., Fujise, Y., Ishikawa, H., Ohsumi, S. and Fukui, Y. 2010. Production of sei whale (*Balaenoptera borealis*) cloned embryos by inter- and intra-species somatic cell nuclear transfer. *Journal of Reproduction and Development* 56: 131–139.

Funakasa, N., Yoshioka, M. and Fujise, Y. 2010. Features of the Ocular Harderian Gland in three Balaenopterid species based on anatomical, histological and histochemical observations. *Mammal Study* 35 (1): 9–15.

Ogawa, G., Ishida, M., Kato, H., Fujise, H. and Urano, N. 2010. Identification of facultative anaerobic bacteria isolated from the intestine of the minke whale *Balaenoptera acutorostrata* by 16S rRNA sequencing analysis. *Fish Sci* 76 (2): 177–181.

Pastene, L.A., Fujise, Y. and Hatanaka, H. 2010. JARPNII: a challenging multidiscipline research program focused on whales in the western North Pacific. *Ottar* (Tromsø Museum) 280: 23–28 (in Norwegian).

Shishido, R., Ohishi, K., Suzuki, R., Takishita, K., Ohtsu, D., Okutsu, K., Tokutake, K., Katsumata, E., Bando, T., Fujise, Y., Murayama, T. and Maruyama, T. 2010. Cetacean Toll-like receptor 4 and myeloid differentiation factor 2, and possible cetacean-specific responses against Gram-negative bacteria. *Comp. Immun. Microbiol. Infect. Dis.* 33 (6): 89–98.

Suzuki, Y., Umatani, M., Bhuiyan, M.M.U., Watanabe, H., Mogoe, T., Matsuoka, K., Fujise, Y., Ishikawa, H., Ohsumi, S., Sasaki, M. and Fukui, Y. 2010. Effects of equilibration steps, type of sugars and addition of whale follicular fluid on viability and in vitro maturation of vitrified whale oocytes. *Jpn. J. Zoo Wildl. Med* 15 (2): 65–72.

Tojo, N., Matsukura, R., Yasuma, H., Yonezaki, S., Watanabe, H., Kawahara, S., Murase, H. and Miyashita, K. 2010. Spatial analysis of isada krill (*Euphausia pacifica*) distribution in frontal environments in the North Pacific Ocean. *GIS/spatial analyses in fisheries and aquatic science*. 4. International Fishery GIS Society: 115–138.

2011 (20)

Hakamada, T. and Matsuoka, K. 2011. Abundance estimate for common minke, Bryde's and sei whales in the offshore region of the western North Pacific. *Bull. Jpn. Soc. Fish. Oceanogr.* 75 (3): 173–174 (in Japanese).

Kanda, N., Goto, M. and Pastene, L. A. 2011. Genetic stock structure of baleen whales. *Bull. Jpn. Soc. Fish. Oceanogr.* 75 (3): 191 (in Japanese).

Kato, H. and Fujise, Y. 2011. General discussion: Symposium on "Marine ecosystem of the western North Pacific with special interest in cetaceans." *Bull. Jpn. Soc. Fish. Oceanogr.* 75 (3): 194–195 (in Japanese).

Kishiro, T., Yoshida, H., Tamura, T., Konishi, K., Kanda, N., Okamoto, R. and Kato, H. 2011. Relationship between maturity and feeding ecology of common minke whales off Kushiro in autumn. *Bull. Jpn. Soc. Fish. Oceanogr.* 75 (3): 175–176 (in Japanese).

Maehara, T., Aoki, I., Yonezaki, S., Watanabe, H., Murase, H. and Yamaguchi, A. 2011. Feeding ecology of the Japanese anchovy in the offshore area east of Honshu, Japan in summer. *Bull. Jpn. Soc. Fish. Oceanogr.* 75 (3): 187 (in Japanese).

Matsuoka, K., Kiwada, H., Fujise, Y. and Miyashita, T. 2011. Distribution of baleen whales in the western North Pacific based on the JARPN and JARPN II sighting surveys (1994 to 2007). *Bull. Jpn. Soc. Fish. Oceanogr.* 75 (3): 178–179 (in Japanese).

Miyashita, K., Matsukura, R., Tojo, N., Minami, K., Yasuma, H., Nagashima, H., Onodera, K., Watanabe, H., Yonezaki, S. and Murase, H. 2011. Monitoring of prey of cetaceans by using quantitative echosounders. *Bull. Jpn. Soc. Fish. Oceanogr.* 75 (3): 183–184 (in Japanese).

Mori, M., Watanabe, H., Hakamada, T., Tamura, T., Konishi, K., Murase, H. and Matsuoka, K. 2011. Development of an ecosystem model of western North Pacific using Ecopath with Ecosim. *Bull. Jpn. Soc. Fish. Oceanogr.* 75 (3): 189 (in Japanese).

Murase, H., Kawabata, A., Kubota, H., Nakagami, M., Amakasu, K., Abe, K., Miyashita, K. and Oozeki, Y. 2011. Effect of depth-dependent target strength on biomass estimation of Japanese anchovy. *Journal of Marine Science and Technology* 19: 267–272.

Murase, H., Tamura, T., Isoda, T., Okamoto, R., Kato, H.,

- Yonezaki, S., Watanabe, H., Tojo, N., Matsukura, R., Miyashita, K., Kiwada, H., Matsuoka, K., Nishiwaki, S., Inagake, D., Okazaki, M., Okamura, H. and Fujise, Y. 2011. Prey selection of common minke, Bryde's and sei whales in the offshore region of the western North Pacific. *Bull. Jpn. Soc. Fish. Oceanogr.* 75 (3): 180–181 (in Japanese).
- Nishiwaki, S., Otani, S. and Tamura, T. 2011. The satellite tracking of the western North Pacific. *Bull. Jpn. Soc. Fish. Oceanogr.* 75 (3): 193–194 (in Japanese).
- Onodera, K., Nagashima, H., Matsukura, R., Miyashita, K., Yonezaki, S. and Murase, H. 2011. Cetacean prey species and oceanographic surveys in Sendai Bay. *Bull. Jpn. Soc. Fish. Oceanogr.* 75 (3): 184–185 (in Japanese).
- Pastene, L.A., Hatanaka, H., Fujise, Y., Kanda, N., Murase, H., Tamura, T., Miyashita, T. and Kato, H. 2011. Whale research program under special permit in the western North Pacific—Phase II (JARPNII): origin and objectives. *Bull. Jpn. Soc. Fish. Oceanogr.* 75 (3): 172–173 (in Japanese).
- Pastene, L.A., Hatanaka, H., Fujise, Y., Kanda, N., Murase, H., Tamura, T., Yasunaga, G., Kishiro, T., Yoshida, H., Miyashita, T. and Kato, H. 2011. The Japanese Whale Research Program under Special Permit in the western North Pacific Phase-II (JARPNII): origin, objectives and research progress made in the first six years period (2002–2007), including scientific considerations for the next research period. *Aquabiology* 33 (2): 171–185 (in Japanese).
- Sasaki, Y., Saito, S., Matsuoka, K., Murase, H. and Kiwada, H. 2011. Spatial distribution patterns of sei and Bryde's whales. *Bull. Jpn. Soc. Fish. Oceanogr.* 75 (3): 179–180 (in Japanese).
- Tamura, T., Konishi, K., Isoda, T., Hakamada, T., Kiwada, H., Okamoto, R. and Matsuoka, K. 2011. The food habitat, relation of habitat factor and prey consumption of three baleen whale species in the offshore region of the western North Pacific. *Bull. Jpn. Soc. Fish. Oceanogr.* 75 (3): 174–175 (in Japanese).
- Watanabe, H., Kiwada, H., Kumagai, S., Yonezaki, S., Kishiro, T., Konishi, K. and Yoshida, H. 2011. Habitat and prey selection of common minke whale off Kushiro in autumn—Estimation of distribution and migration of common minke whale using environmental information—*Bull. Jpn. Soc. Fish. Oceanogr.* 75 (3): 182–183 (in Japanese).
- Yamaguchi, A., Hanamiya, Y., Murase, H. and Watanabe, H. 2011. Vertical flux of materials by diel vertical migration of macrozooplankton. *Bull. Jpn. Soc. Fish. Oceanogr.* 75 (3): 185–186 (in Japanese).
- Yasunaga, G. and Fujise, Y. 2011. Monitoring of pollutants in the baleen whales and their prey species in the western North Pacific. *Bull. Jpn. Soc. Fish. Oceanogr.* 75 (3): 190 (in Japanese).
- Yoshida, H., Kishiro, T., Goto, M., Bando, T., Tamura, T., Konishi, K., Okamoto, R. and Kato, H. 2011. Feeding ecology of common minke whales in coastal waters off Sanriku in spring. *Bull. Jpn. Soc. Fish. Oceanogr.* 75 (3): 177–178 (in Japanese).
- 2012 (4)**
- Maeda, H. and Kato, H. 2012. Technical improvements of the age character (earplug) collections in common minke whales. *Bull. Jpn. Soc. Fish. Oceanogr.* 76 (2): 59–65 (in Japanese).
- Murase, H., Kawabata, A., Kubota, H., Nakagami, M., Amakasu, K., Abe, K., Miyashita, K. and Oozeki, Y. 2012. Basin-scale distribution patterns and biomass estimation of Japanese anchovy *Engraulis japonicus* in the western North Pacific. *Fish Sci* 78 (4): 761–773.
- Nakamura, G., Kato, H. and Fujise, Y. 2012. Relative growth of the skull of the common minke whale *Balaenoptera acutorostrata* from the North Pacific in comparison to other *Balaenoptera* species. *Mammal Study* 37 (2): 105–112.
- Watanabe, H., Okazaki, M., Tamura, T., Konishi, K., Inagake, D., Bando, T., Kiwada, H. and Miyashita, T. 2012. Habitat and prey selection of common minke, sei, and Bryde's whale in mesoscale during summer in the sub-arctic and transition regions of the western North Pacific. *Fish Sci* 78 (3): 557–567.
- 2013 (5)**
- *Kershaw, F., Leslie, M.S., Collins, T., Mansur, R.M., Smith, B.D., Minton, G., Baldwin, R., LeDuc, R.G., Anderson, R.C., Brownell, R.L. and Rosenbaum, H.C. 2013. Population differentiation of 2 forms of Bryde's whales in the Indian and Pacific Oceans. *Journal of Heredity* 104 (6): 755–764.
- Maeda, H., Kawamoto, T. and Kato, H. 2013. A study on the improvement of age estimation in common minke whales using the method of gelatinized extraction of earplug. *NAMMCO Scientific Publications* 10: 17pp.
- Matsukura, R., Sawada, K., Abe, K., Minami, K., Nagashima, H., Yonezaki, S., Murase, H. and Miyashita, K. 2013. Comparison of measurements and model calculations of target strength of juvenile sandeel in Sendai Bay. *Nippon Suisan Gakkaishi* 79 (4): 638–648 (in Japanese).
- Sasaki, H., Murase, H., Kiwada, H., Matsuoka, K., Mitani, Y.

and Saitoh, S. 2013. Habitat differentiation between sei (*Balaenoptera borealis*) and Bryde's whales (*B. brydei*) in the western North Pacific. *Fish. Oceanogr.* 22 (6): 496–508.

Shimizu, Y., Ohishi, K., Suzuki, R., Tajima, Y., Yamada, T., Kakizoe, Y., Bando, T., Fujise, Y., Taru, H., Murayama, T. and Maruyama, T. 2013. Amino acid sequence variations of signaling lymphocyte activation molecule and mortality caused by morbillivirus infection in cetaceans. *Microbiol Immunol* 57: 624–632.

2014 (6)

Inoue, S., Kishiro, T., Fujise, Y., Nakamura, G. and Kato, H. 2014. Seasonal changes in the testis of the North Pacific common minke whale. *Nippon Suisan Gakkaishi* 80 (2): 185–190 (in Japanese).

Murase, H., Hakamada, T., Matsuoka, K., Nishiwaki, S., Inagake, D., Okazaki, M., Tojo, N. and Kitakado, T. 2014. Distribution of sei whales (*Balaenoptera borealis*) in the subarctic–subtropical transition area of the western North Pacific in relation to oceanic fronts. *Deep Sea Research Part II: Topical Studies in Oceanography* 107: 22–28.

Nakamura, G., Kadowaki, I., Nagatsuka, S., Fujise, Y., Kishiro, T. and Kato, H. 2014. Variation in a color pattern of white patch on the flippers of North Pacific common minke whales: potential application for their interoceanic difference. *La mer* 52: 31–47.

Nakamura, G. and Kato, H. 2014. Developmental changes in the skull morphology of common minke whales *Balaenoptera acutorostrata*. *Journal of Morphology* 275: 1113–1121.

Niimi, S., Imoto, M., Kunisue, T., Watanabe, M.X., Kim, E.Y., Nakayama, K., Yasunaga, G., Fujise, Y., Tanabe, S. and Iwata, H. 2014. Effects of persistent organochlorine exposure on the liver transcriptome of the common minke whale (*Balaenoptera acutorostrata*) from the North Pacific. *Ecotoxicology and Environmental Safety* 108: 95–105.

*Rosel, P.E. and Wilcox, L.A. 2014. Genetic evidence reveals a unique lineage of Bryde's whales in the northern Gulf of Mexico. *Endang Species Res.* 25: 19–34.

2015 (1)

Kitayama, C., Sasaki, M., Ishikawa, H., Mogoe, T., Ohsumi, S., Fukui, Y., Budipitojo, T., Kondoh, D. and Kitamura, N. 2015. Structure and functions of the placenta in common minke (*Balaenoptera acutorostrata*), Bryde's (*B. brydei*) and sei (*B. borealis*) whales. *Journal of Reproduction and Development* 61 (5): 415–421.

2016 (6)

Hirako, S., Suzuki, M., Kim, H., Iizuka, Y., Matsumoto, A., Wada, N., Okabe, M., Takenoya, F., Yasunaga, G., Yamanaka, S., Miyazaki, A. and Shioda, S. 2016. Hepatic lipid accumulation is ameliorated in obese KK mice by dietary sei whale oil. *Fish Sci* 82 (3): 509–517.

Miyakawa, N., Kishiro, T., Fujise, Y., Nakamura, G. and Kato, H. 2016. Sexual Dimorphism in Pelvic Bone Shape of the North Pacific Common Minke Whales (*Balaenoptera acutorostrata*). *Open Journal of Animal Sciences* 6: 131–136.

Murase, H., Tamura, T., Otani, S. and Nishiwaki, S. 2016. Satellite tracking of Bryde's whales *Balaenoptera edeni* in the offshore western North Pacific in summer 2006 and 2008. *Fish Sci* 82 (1): 35–45.

Nakamura, G., Kadowaki, I., Nagatsuka, S., Hayashi, R., Kanda, N., Goto, M., Pastene, L.A. and Kato, H. 2016. White Patch on the Fore-Flipper of Common Minke Whale, as a Potential morphological Index to Identify Stocks. *Open Journal of Animal Sciences* 6: 116–122.

Nakamura, G., Takahashi, M., Hirose, A., Hayashi, R., Fujise, Y., Miyakawa, N., Inoue, S. and Kato, H. 2016. Presence of an interparietal bone and morphological variation in the vertex of the skull in North Pacific common minke whale. *La mer* 54 (1): 1–10.

Ohishi, K., Bando, T., Abe, E., Kawai, Y., Fujise, Y. and Maruyama, T. 2016. Long-term and large-scale epidemiology of *Brucella* infection in baleen whales and sperm whales in the western North Pacific and Antarctic Oceans. *J. Vet. Med. Sci.* 78 (9): 1457–1464.

2017 (2)

Bando, T., Nakamura, G., Fujise, Y. and Kato, H. 2017. Developmental changes in the morphology of western North Pacific Bryde's whales (*Balaenoptera edeni*). *Open Journal of Animal Sciences* 7: 344–355.

Ishii, M., Murase, H., Fukuda, Y., Sawada, K., Sasakura, T., Tamura, T., Bando, T., Matsuoka, K., Shinohara, A., Nakatsuka, S., Katsumata, N., Okazaki, M., Miyashita, K. and Mitani, Y. 2017. Diving behavior of sei whales *Balaenoptera borealis* relative to the vertical distribution of their potential prey. *Mammal Study* 42 (4): 191–199.

2018 (2)

Huijser, L.A.E., Bérubé, M., Cabrera, A.A., Prieto, R., Silva, M.A., Robbins, J., Kanda, N., Pastene, L.A., Goto, M., Yoshida, H., Vikingsson, G.A. and Palsbøll, P.J. 2018. Population structure of North Atlantic and North Pacific sei whales (*Balaenoptera borealis*) inferred from

mitochondrial control region DNA sequences and microsatellite genotypes. *Conserv Genet* 19: 1007–1024.

Watari, S., Murase, H., Yonezaki, S., Okazaki, M., Kiyofuji, H., Tamura, T., Hakamada, T., Kanaji, Y. and Kitakado, T. 2018. Ecosystem modeling in the western North Pacific using Ecopath, with a focus on small pelagic fishes. *Mar. Ecol. Prog. Ser.*: <https://doi.org/10.3354/meps12508>.

Other surveys

1993 (1)

Fujise, Y., Ishikawa, H., Saino, S. and Kawasaki, M. 1993. Catch and struck-and-lost rate in the Japanese Dall's porpoise hand-harpoon fishery. *Rep. int. Whal. Commn* 43: 453–457.

1995 (1)

Shimada, H. and Pastene, L.A. 1995. Report of a sightings survey off the Solomon Islands with comments on Bryde's whale distribution. *Rep. Int. Whal. Commn* 45: 413–418.

1997 (4)

Kimura, T., Ozawa, T. and Pastene, L.A. 1997. Sample preparation and analysis of mitochondrial DNA from whale baleen plates. *Marine Mammal Science* 13 (3): 495–498.

Ljungblad, D.K., Stafford, K.M., Shimada, H. and Matsuo-ka, K. 1997. Sounds attributed to blue whales recorded off the southwest coast of Australia in December 1995. *Rep. int. Whal. Commn* 47: 435–439.

Ohmagari, K. and Berkes, F. 1997. Transmission of indigenous knowledge and bush skills among the Western James Bay Cree Women of Subarctic Canada. *Human Ecology* 25 (2): 197–222.

Shimamura, M., Yasue, H., Ohshima, K., Abe, H., Kato, H., Kishiro, T., Goto, M., Munechika, I. and Okada, N. 1997. Molecular evidence from retroposons that whales form a clade within even-toed ungulates. *Nature* 388: 666–670.

1998 (2)

Miyazaki, N., Fujise, Y. and Iwata, K. 1998. Biological analysis of a mass stranding of melon-headed whales (*Peponocephala electra*) at Aoshima. *Japan. Bull. Natn. Sci. Mus., Tokyo, Ser. A* 24 (1): 31–60.

Otani, S., Naito, Y., Kawamura, A., Kawasaki, M., Nishiwaki, S. and Kato, A. 1998. Diving behavior and performance of harbor porpoises, *Phocoena phocoena*, in Fukuoka bay, Hokkaido, Japan. *Marine Mammal*

Science 14 (2): 209–220.

1999 (4)

Iino, Y. 1999. Treaty Implementation: the 1946 International Convention for the Regulation of Whaling. System Compliance in Ocean Management. Southeast Asian Programme in Ocean Law. *Policy and Management*: 189–193.

Pastene, L.A. and Shimada, H. 1999. Report of a sighting survey in Chile's Exclusive Economic Zone with comments on sei whale distribution. *Anales Instituto Patagonia, Serie Cs. Nat.* 27: 51–62.

Shimamura, M., Abe, H., Nikaido, M., Ohshima, K. and Okada, N. 1999. Genealogy of families of SINES in cetaceans and artiodactyls: the presence of a huge superfamily of tRNA^{Glu}-derived families of SINEs. *Mol. Biol. Evol.* 16 (8): 1046–1060.

Yoshida, H. and Kato, H. 1999. Phylogenetic relationships of Bryde's whales in the Western North Pacific and adjacent waters inferred from mitochondrial DNA sequences. *Marine Mammal Science* 15 (4): 1269–1286.

2000 (3)

Goto, M. and Ohsumi, S. 2000. Response to "Scientific Whaling Source of illegal Products for Market" By Baker *et al.* *Science* 290: 1695–1696.

Otani, S., Naito, Y., Kato, A. and Kawamura, A. 2000. Diving behavior and swimming speed of a free-ranging harbor porpoise, *Phocoena phocoena*. *Marine Mammal Science* 16 (4): 811–814.

Takahashi, S., Le, L.T.H., Saeki, H., Nakatani, N., Tanabe, S., Miyazaki, N. and Fujise, Y. 2000. Accumulation of butyltin compounds and total tin in marine mammals. *Water Science and Technology* 42 (7–8): 97–108.

2001 (2)

Abe, H., Goto, M., Pastene, L.A., Dewa, K. and Naito, E. 2001. Practical use of multiplex fluorescent PCR for cetacean sex identification. *Marine Mammal Science* 17 (3): 657–664.

Yoshida, H., Yoshioka, M., Shirakihara, M. and Chow, S. 2001. Population structure of finless porpoises (*Neophocaena phocaenoides*) in coastal waters of Japan based on mitochondrial DNA sequences. *Journal of Mammalogy* 82 (1): 123–130.

2002 (1)

Konishi, K. and Sakurai, Y. 2002. Geographical variations in infection by larval *Anisakis simplex* and *Contracaecum osculatatum* (Nematoda, Anisakidae) in walleye pollock

Theragra chalcogramma stocks off Hokkaido, Japan. *Fish Sci* 68 (3): 534–542.

2003 (1)

Matsuoka, K., Ensor, P., Hakamada, T., Shimada, H., Nishiwaki, S., Kasamatsu, F. and Kato, H. 2003. Overview of the minke whale sighting survey in IWC/IDCR and SOWER cruises from 1978/79 to 2000/01. *J. Cetacean Res. Manage.* 5 (2): 173–201.

2004 (5)

Branch, T.A., Matsuoka, K. and Miyashita, T. 2004. Evidence for increases in Antarctic blue whales based on Bayesian modelling. *Marine Mammal Science* 20 (4): 726–754.

Escorza-Trevino, S., Pastene, L.A. and Dizon, A.E. 2004. Molecular analyses of the Truei and Dall morphotypes of Dall's porpoise (*Phocoenoides dalli*). *Journal of Mammalogy* 85 (2): 347–355.

Ikemoto, T., Kunito, T., Watanabe, I., Yasunaga, G., Baba, N., Miyazaki, N., Petrov, E.A. and Tanabe, S. 2004. Comparison of trace element accumulation in Baikal seals (*Pusa sibirica*), Caspian seals (*Pusa caspica*) and northern fur seals (*Callorhinus ursinus*). *Environmental Pollution* 127: 83–97.

Murase, H., Matsuoka, K., Nishiwaki, S., Hakamada, T. and Mori, M. 2004. Effect of observed covariates (school size, sighting cue, latitude and sea state) on the Antarctic minke whale abundance estimation parameters in the IWC/IDCR-SOWER surveys. *J. Cetacean Res. Manage.* 6 (3): 283–292.

Yanagimoto, T. and Konishi, K. 2004. *Acanthochondria priacanthi* (Copepoda: Chondracanthidae) as a biological indicator for stock identification of sandfish *Arctoscoopus japonicus* (Steindachner). *Fish Sci* 70 (2): 336–338.

2005 (5)

Agusa, T., Matsumoto, T., Ikemoto, T., Anan, Y., Kubota, R., Yasunaga, G., Kunito, T., Tanabe, S., Ogi, H. and Shibata, Y. 2005. Body distribution of trace elements in black-tailed gulls from Rishiri Island, Japan: age-dependent accumulation and transfer to feathers and eggs. *Environ. Toxicol. Chem.* 24 (9): 2107–2120.

Agusa, T., Kunito, T., Yasunaga, G., Iwata, H., Subramanian, A., Ismail, A. and Tanabe, S. 2005. Concentrations of trace elements in marine fish and its risk assessment in Malaysia. *Marine Pollution Bulletin* 51 (8–12): 896–911.

Fukui, Y., Ishikawa, H. and Ohsumi, S. 2005. Difficulties in publishing research results from scientific whaling.

Marine Mammal Science 21 (4): 781–783.

Prudente, M., Tanabe, S., Kunisue, T., Yasunaga, G., Watanabe, I. and Miyazaki, N. 2005. Accumulation of trace elements and persistent organochlorines in resident and migratory waders from Calatagan Bay, Philippines. *Coastal Marine Science* 29 (2): 133–140.

Sanino, G.P., Waerebeek, K.V., Van Bresseem, M. and Pastene, L.A. 2005. A preliminary note on population structure in eastern South Pacific common bottlenose dolphins, *Tursiops truncatus*. *J. Cetacean Res. Manage.* 7 (1): 65–70.

2006 (6)

Acevedo, J., Aguayo-Lobo, A. and Pastene, L.A. 2006. Filopatría de la ballena jorobada (*Megaptera novaeangliae* Borowski, 1781), al área de alimentación del Estrecho de Magallanes. *Revista de Biología Marina y Oceanografía* 41 (1): 11–19.

Acevedo, J., Aguayo-Lobo, A., Acuna, P. and Pastene, L.A. 2006. A note on the first record of the dwarf minke whale (*Balaenoptera acutorostrata*) in Chilean waters. *J. Cetacean Res. Manage.* 8 (3): 293–296.

Hayashi, K., Yoshida, H., Nishida, S., Goto, M., Pastene, L.A., Kanda, N., Baba, H. and Koike, H. 2006. Genetic Variation of the MHC DQB locus in the finless porpoise (*Neophocaena phocaenoides*). *Zoological Science* 23 (2): 147–153.

Mori, M. and Butterworth, D.S. 2006. A first step towards modelling the krill–predator dynamics of the Antarctic ecosystem. *CCAMLR Science* 13: 217–277.

Sekiguchi, K., Olavarria, C., Morse, P., Olson, P., Ensor, P., Matsuoka, K., Pitman, R., Findlay, K. and Gorter, U. 2006. The spectacled porpoise (*Phocoena dioptrica*) in Antarctic waters. *J. Cetacean Res. Manage.* 8 (3): 265–271.

Takahashi, Y., Ohwada, S., Watanabe, K., Ropert-Coudert, Y., Zenitani, R., Naito, Y. and Yamaguchi, T. 2006. Does elastin contribute to the persistence of corpora albicantia in the ovary of the common dolphin (*Delphinus delphis*). *Marine Mammal Science* 22 (4): 819–830.

2007 (2)

Acevedo, J., Rasmussen, K., Felix, F., Castro, C., Llano, M., Secchi, E., Saborio, M.T., Aguayo-Lobo, A., Haase, B., Scheidat, M., Dalla-Rosa, L., Olavarria, C., Fosestell, P., Acuna, P., Kaufman, G. and Pastene, L.A. 2007. Migratory destinations of humpback whales from the Magellan Strait feeding ground, Southeast Pacific. *Marine Mammal Science* 23 (2): 453–463.

Branch, T.A., Stafford, K.M., Palacios, D.M., Allison, C.,

Bannister, J.L., Burton, C.L.K., Cabrera, E., Carlson, C.A., Galletti Vernazzani, B., Gill, P.C., Huckle-Gaete, R., Jenner, K.C.S., Jenner, Mn. M., Matsuoka, K., Mikhalev, Y.A., Miyashita, T., Morrice, M.G., Nishiwaki, S., Sturrock, V.J., Tormosov, D., Anderson, R.C., Baker, A.N., Best, P.B., Borsa, P., Brownell Jr, R.L., Childerhouse, S., Findlay, K.P., Gerrodette, T., Ilangakoon, A.D., Jørgensen, M., Kahn, B., Ljungblad, D.K., Maughan, B., McCauley, R.D., Mckay, S., Norris, T.F., Oman Whale and Dolphin Research Group, Rankin, S., Samaran, F., Thiele, D., Van Waerebeek, K. and Warneke, R.M. 2007. Past and present distribution, densities and movements of blue whales in the Southern Hemisphere and adjacent waters. *Mammal Rev.* 37 (2): 116–175.

2009 (1)

Nambu, H., Tokutake, K., Ishikawa, H., Ohta, M., Fujita, K. and Yamada, T.K. 2009. Observation of a gray whale, *Eschrichtius robustus*, in Tokyo Bay in 2005. *Japan Cetology* 19: 17–22 (in Japanese).

2010 (3)

Nambu, H., Ishikawa, H. and Yamada, T. 2010. Records of the western gray whale *Eschrichtius robustus*: its distribution and migration. *Japan Cetology* 20: 21–29 (in Japanese).

Pastene, L.A. and Quiroz, D. 2010. An Outline of the History of Whaling in Chile. pp. 73–98. *In: International Center for Folk Culture Studies (Ed). Human Culture from the Perspective of Traditional Maritime Communities, International Symposium Report No. 1.* Kanagawa Shimbun Press, Kanagawa. 199pp.

Taguchi, M., Ishikawa, H. and Matsuishi, T. 2010. Seasonal distribution of harbour porpoise (*Phocoena phocoena*) in Japanese waters inferred from stranding and bycatch records. *Mammal Study* 35 (2) : 133–138.

2011 (2)

Acevedo, J., Olavarría, C., Plana, J., Aguayo-Lobo, A., Larrea, A. and Pastene, L.A. 2011. Occurrence of dwarf minke whales (*Balaenoptera acutorostrata* subsp.) around the Antarctic Peninsula. *Polar Biol* 34 (2): 313–318.

Acevedo, J., Plana, J., Aguayo-Lobo, A. and Pastene, L.A. 2011. Surface feeding behavior of humpback whales in the Magellan Strait. *Revista de Biología Marina y Oceanografía*. 46 (3): 483–490.

2013 (4)

Acevedo J., Haro D., Dalla R.L., Aguayo-Lobo A., Huckle-

Gaete R., Secchi E., Plana J. and Pastene L.A. 2013. Evidence of spatial structuring of eastern South Pacific humpback whale feeding grounds. *Endang Species Res* 22 (1): 33–38.

Kitamura, S., Matsuishi, T., Yamada, K., Tajima, Y., Ishikawa, H., Tanabe, S., Nakagawa, H., Uni, Y. and Abe, S. 2013. Two genetically distinct stocks in Baird's beaked whale (Cetacea: Ziphiidae). *Marine Mammal Science* 29 (4): 755–766.

Murase, H., Temoai, I., Kirata, T., Finkaso, S., Yasunaga, G. and Pastene, L.A. 2013. A note on cetaceans off Kiribati and Tuvalu from a research cruise in October 2010. *J. Cetacean Res. Manage.* 13 (2): 153–158.

Sugino, T., Yasunaga, G. and Fukuda, M. 2013. Effect of whale meat extract on fatigue induced by physical load and by daily activities in humans. *Jpn. Pharmacol. Ther* 41 (9): 879–893 (in Japanese).

2014 (3)

Pastene, L.A. 2014. Macaya Hermanos y Compania. Notas sobre las actividades de la empresa ballenera de más larga historia en Chile. Colección Mocha Dick pp 255–274.

Quiroz, D. and Pastene, L.A. 2014. Norwegian whaling in Chile in the 20th Century and its influence on Chilean local communities. pp. 61–70. *In: Jan Erik Ringstad (Ed). Whaling and History IV.* Commander Chr. Christensen's Whaling Museum, part of Vestfoldmuseene IKA, Sandefjord. 192pp.

Quintela, M., Skaug, H.J., Øien, N., Haug, T., Seliussen, B.B., Solvang, H.K., Pampoulie, C., Kanda, N., Pastene, L.A. and Glover, K.A. 2014. Investigating population genetic structure in a highly mobile marine organism: the minke whale *Balaenoptera acutorostrata acutorostrata* in the North East Atlantic. *PLoS ONE* 9 (9): e108640.

2015 (3)

Funasaka, N., Kirihata, T., Kato, H. and Ohsumi, S. 2015. The first record of a true albino common bottlenose dolphin *Tursiops truncatus* from Japan. *Mammal Study* 40 (1): 19–22.

Pastene, L.A., Acevedo, J., Siciliano, S., Sholl, T.G.C., de Moura, J.F., Ott, P.H. and Aguayo-Lobo, Anelio. 2015. Population genetic structure of the South American Bryde's whale. *Revista de Biología Marina y Oceanografía* 50 (3): 453–464.

Sakamoto, M., Itai, T., Yasutake, A., Iwasaki, T., Yasunaga, G., Fujise, Y., Nakamura, M., Murata, K., Chan, H.M., Domingog, J.L. and Marumoto, M. 2015. Mercury speciation and selenium in toothed-whale muscles.

Environmental Research 143: 55–61.

2017 (3)

Funasaka, N., Kirihata, T., Hosono, M., Kato, K. and Ohsumi, S. 2017. Three Cases of Anomalously White Risso's Dolphins *Grampus griseus* in Japan. *Mammal Study* 42 (3): 173–178.

Hakamada, T., Matsuoka, K., Murase, H. and Kitakado, T. 2017. Estimation of the abundance of the sei whale *Balaenoptera borealis* in the central and eastern North

Pacific in summer using sighting data from 2010 to 2012. *Fish Sci* 83 (6): 887–895.

Malde, K., Seliussen, B.B., Quintela, M., Dahle, G., Besnier, F., Skaug, H.J., Øien, N., Solvang, H.K., Haug, T., Skern-Mauritzen, R., Kanda, N., Pastene, L.A., Jonassen, I. and Glover, K.A. 2017. Whole genome resequencing reveals diagnostic markers for investigating global migration and hybridization between minke whale species. *BMC Genomics* 18: 76.

TEREP-ICR

The Institute of Cetacean Research,
4-5 Toyomi-cho, Chuo-ku, Tokyo 104-0055, Japan
www.icrwhale.org/TEREP-ICR.html